



ERKADO

2022
Edition I/2022

WOODEN DOORS EXTERNAL AND INTERNAL

EDITION: I/2022
effective from 1.03.2022

EN

WOODEN EXTERIOR DOORS



BOARD TECHNOLOGY

THE KEY FEATURE OF THE "P" EXTERNAL DOORS IS THEIR INNOVATIVE PRODUCTION TECHNOLOGY

This technology preserves the beauty of wooden doors while eliminating most of the problems associated with traditional board technologies, such as: tearing and shifting of door coffers, warping of leaves, uneven discolouration of individual door elements, cracking and corrugation of veneers, and problems with joint fillers.



ROBUST DESIGN



The door is designed to maintain good thermal and acoustic insulation properties. Our doors feature a pine-meranti or pine-oak frame reinforced with sheet metal and a "C" shaped profile. It is up to you to decide how thick they are to be. The doors can be 72, 82 or 102 mm thick, but their design remains the same. Inside, between the sheathing made of a 7 or 12 mm thick waterproof mahogany, meranti pine or oak plywood is a truss filled with polyurethane foam.



SAFETY



All doors have an anti-burglary protection in the form of a multipoint lock (or two independent locks), durable and robust hinges, and a sheet metal reinforcement to provide a sense of safety and prevent burglary.



ECOLOGY

Our doors are manufactured using ecological water-soluble varnishes and wood from legal Polish forests. The waste generated during production is collected and recycled, and the production process is safe for our employees.

LACQUER

- The wood used to make veneers differs in terms of colour, texture and consistency. Even a single tree may feature significant differences in this respect. These are the characteristic features of natural wood and may not be claimed.
- The presented colours are for illustrative purposes only and should not be used as colour samples.

FINISHING



STANDARD STRAIGHT OAK



KNOTTY OAK¹⁾

¹⁾ additional charge. The grain direction can be vertical or horizontal



NATURAL OAK¹⁾



DARK OAK



TEAK



WALNUT



WHITE



WINCHESTER



GOLDEN OAK



MAHOGANY



ROSEWOOD



RAL 7016



RAL COLOUR RANGE²⁾

EXTERNAL DOORS

GLASS line	4
INOX line	7
MODERN line.....	17
CLASSIC line	31
DECOR line.....	42
EXTENSIONS / ADDITIONS	44

INTERIOR WOODEN DOORS

UNO PREMIUM	58
BALDUR	60
MISKANT	62
TURAN	64
MILDA	66
ANUBIS	68
SYLENA	70
LOFT	72
DOOR FRAMES AND HARDWARE FOR INTERNAL DOORS	74

TECHNICAL INFORMATION	75
PIVOT DOORS	79
CLEAN AIR CERTIFICATES	80
GLAZING PACKAGES	81
ADDITIONAL FEES FOR EXTERNAL DOORS	83
ACCESSORIES FOR EXTERNAL DOORS	84

Decorated with a black glass, the Glass line of timber doors perfectly complements modern buildings. Natural wood combined with a glossy black glass is a chic and timeless combination.

Finishing material:

- meranti, oak or pine

Design:

- a gasket in the leaf and the frame
- a burglary-proof rebate on the hinges side
- the external surface of the leaf made of waterproof plywood
- internal structure of the leaf in the form of a truss with a polyurethane foam filling
- the leaf tiles made of wood reinforced with sheet metal and a "C" profile

Standard set:

- thickness: 72 mm
- two independent bolt locks
- four hinges adjustable in three planes
- glazing package REFLEX BRONZE
- an aluminium threshold with a thermal separator or a wooden threshold



P123

DOOR THICKNESS

- ◀ 72 ▶ ◀ 82 ▶ ◀ 102 ▶

TYPE



FINISHING

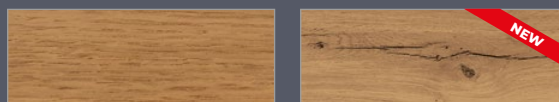

STANDARD STRAIGHT OAK

KNOTTY OAK¹⁾

¹⁾ additional charge. The grain direction can be vertical or horizontal

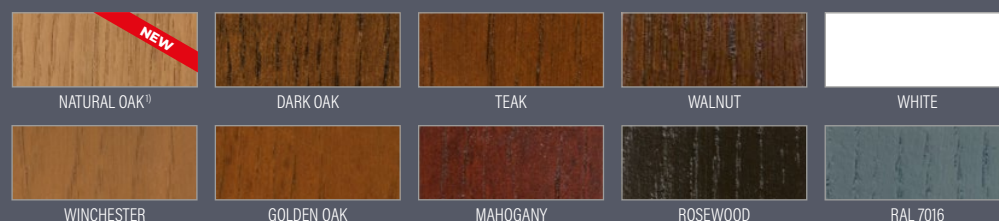

RAL COLOUR RANGE²⁾

¹⁾ additional charge. Available with plain or shallow-milled door

²⁾ additional charge



P120



P121



P122



P123

Knotty grain for an extra charge



P124

Knotty grain for an extra charge



P125

Knotty grain for an extra charge

NON-REBATED DOORS - a additional charge applicable to the 82 and 102 mm-thick rebated doors.
Lacquered glass is only available on one side on the outside.

The ERKADO doors are available in non-standard dimensions **without an extra charge** for non-standard dimensions. The additional charge only applies to the following doors: higher than 212 cm and wider than 102 cm.





P126

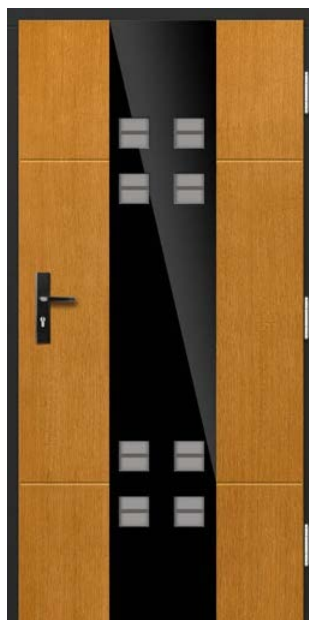

P127



P152

Knotty grain for an extra charge



P153

Knotty grain for an extra charge



P154

Knotty grain for an extra charge

NON-REBATED DOORS - a additional charge applicable to the 82 and 102 mm-thick rebated doors.
Lacquered glass is only available on one side on the outside.

The ERKADO doors are available in non-standard dimensions **without an extra charge** for non-standard dimensions. The additional charge only applies to the following doors: higher than 212 cm and wider than 102 cm.

Precious brushed aluminium combined with natural wood to provide top design. The Inox panel additionally protects the door surface against external damage.

Finishing material:

- meranti, oak or pine

Design:

- a gasket in the leaf and the frame
- a burglary-proof rebate on the hinges side
- the external surface of the leaf made of waterproof plywood
- internal structure of the leaf in the form of a truss with a polyurethane foam filling
- the leaf tiles made of wood reinforced with sheet metal and a "C" profile

Standard set:

- thickness: 72 mm
- two independent bolt locks
- four hinges adjustable in three planes
- glazing package REFLEX BRONZE
- an aluminium threshold with a thermal separator or a wooden threshold



P99

DOOR THICKNESS

- ◀ 72 ▶ ▶ 82 ▶ ▶ 102 ▶

TYPE



FINISHING

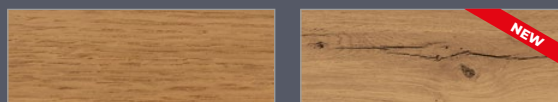

STANDARD STRAIGHT OAK

KNOTTY OAK¹⁾

¹⁾ additional charge. The grain direction can be vertical or horizontal

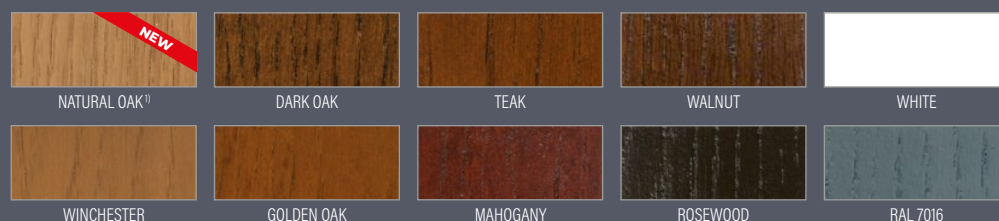

NATURAL OAK¹⁾

DARK OAK

TEAK

WALNUT

WHITE

WINCHESTER

GOLDEN OAK

MAHOGANY

ROSEWOOD

RAL 7016



RAL COLOUR RANGE²⁾

¹⁾ additional charge. Available with plain or shallow-milled door

²⁾ additional charge



P128

Additional charge for a double-sided inox



P129

Additional charge for a double-sided inox



P60

Additional charge for a double-sided inox



P150

Additional charge for a double-sided inox



P136

Additional charge for a double-sided inox
Double colour for an additional charge



P57

Additional charge for a double-sided inox
Double colour for an additional charge

NON-REBATED DOORS - a additional charge applicable to the 82 and 102 mm-thick rebated doors.
Lacquered glass is only available on one side on the outside.

The ERKADO doors are available in non-standard dimensions **without an extra charge** for non-standard dimensions. The additional charge only applies to the following doors:
higher than 212 cm and wider than 102 cm.



P70

Additional charge for a double-sided inox



P48

Additional charge for a double-sided inox



P42

Additional charge for a double-sided inox



¹⁾ additional charge. Available with plain or shallow-milled door

²⁾ additional charge



NON-REBATED DOORS - a additional charge applicable to the 82 and 102 mm-thick rebated doors.

Lacquered glass is only available on one side on the outside.

The ERKADO doors are available in non-standard dimensions **without an extra charge** for non-standard dimensions. The additional charge only applies to the following doors: higher than 212 cm and wider than 102 cm.





P99

Additional charge for a double-sided inox



P68

Additional charge for a double-sided inox
Glazing for extra charge



P130

Additional charge for a double-sided inox



P44

Additional charge for a double-sided inox

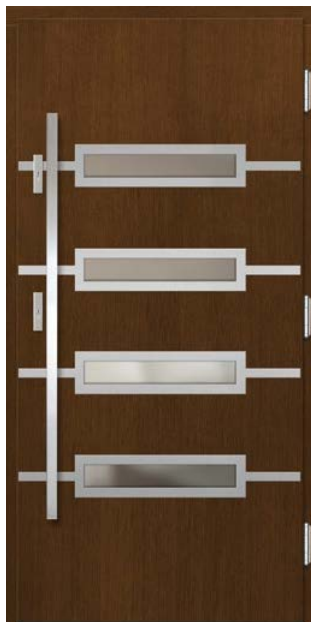

P91

Additional charge for a double-sided inox



P100

Additional charge for a double-sided inox

NON-REBATED DOORS - a additional charge applicable to the 82 and 102 mm-thick rebated doors.
Lacquered glass is only available on one side on the outside.

The ERKADO doors are available in non-standard dimensions **without an extra charge** for non-standard dimensions. The additional charge only applies to the following doors: higher than 212 cm and wider than 102 cm.



P105

Additional charge for a double-sided inox



P46

Additional charge for a double-sided inox



P104

A additional charge for a double-sided inox + lower kick plate made of steel



¹⁾ additional charge. Available with plain or shallow-milled door

²⁾ additional charge



NON-REBATED DOORS - a additional charge applicable to the 82 and 102 mm-thick rebated doors.

Lacquered glass is only available on one side on the outside.

The ERKADO doors are available in non-standard dimensions **without an extra charge** for non-standard dimensions. The additional charge only applies to the following doors: higher than 212 cm and wider than 102 cm.



P155

Additional charge for a double-sided inox



P101

Additional charge for a double-sided inox



P95

Additional charge for a double-sided inox



¹⁾ additional charge. Available with plain or shallow-milled door

²⁾ additional charge



NON-REBATED DOORS - a additional charge applicable to the 82 and 102 mm-thick rebated doors.
Lacquered glass is only available on one side on the outside.

The ERKADO doors are available in non-standard dimensions **without an extra charge** for non-standard dimensions. The additional charge only applies to the following doors: higher than 212 cm and wider than 102 cm.



P66

Additional charge for a double-sided inox



P133

Additional charge for a double-sided inox



P56

Additional charge for a double-sided inox



P156

Knotty grain for an extra charge
additional charges: a double-sided inox
+ double colour



P158

Additional charge for a double-sided inox

NON-REBATED DOORS - a additional charge applicable to the 82 and 102 mm-thick rebated doors.
Lacquered glass is only available on one side on the outside.

The ERKADO doors are available in non-standard dimensions **without an extra charge** for non-standard dimensions. The additional charge only applies to the following doors: higher than 212 cm and wider than 102 cm.





P58

Additional charge for a double-sided inox



P97

Additional charge for a double-sided inox



P134

Additional charge for a double-sided inox



P81

Additional charge for a double-sided inox

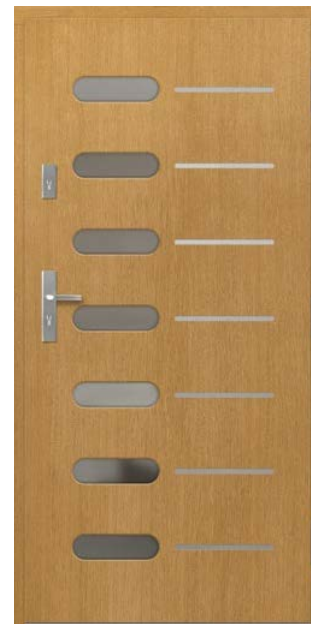

P64

Additional charge for a double-sided inox



P102

Additional charge for a double-sided inox

NON-REBATED DOORS - a additional charge applicable to the 82 and 102 mm-thick rebated doors. Lacquered glass is only available on one side on the outside.

The ERKADO doors are available in non-standard dimensions **without an extra charge** for non-standard dimensions. The additional charge only applies to the following doors: higher than 212 cm and wider than 102 cm.



P89

additional charges: double-sided inox + stained glass



P90

additional charges: double-sided inox + stained glass



P103

additional charges: double-sided inox + stained glass



¹⁾ additional charge. Available with plain or shallow-milled door

²⁾ additional charge



NON-REBATED DOORS - a additional charge applicable to the 82 and 102 mm-thick rebated doors.

Lacquered glass is only available on one side on the outside.

The ERKADO doors are available in non-standard dimensions **without an extra charge** for non-standard dimensions. The additional charge only applies to the following doors: higher than 212 cm and wider than 102 cm.





P131

additional charge for a double-sided inox



P132

additional charge for a double-sided inox
+ stained glass



P135

additional charge for a double-sided inox
+ double colour



P106

additional charge for a double-sided inox



P98

additional charge for a double-sided inox

NON-REBATED DOORS - a additional charge applicable to the 82 and 102 mm-thick rebated doors.
Lacquered glass is only available on one side on the outside.

The ERKADO doors are available in non-standard dimensions **without an extra charge** for non-standard dimensions. The additional charge only applies to the following doors:
higher than 212 cm and wider than 102 cm.

The characteristic feature of this line is its modern-looking milling and glazing. The models are characterized by a coherent design based on geometric figures.

Finishing material:

- meranti, oak or pine

Design:

- a gasket in the leaf and the frame
- a burglary-proof rebate on the hinges side
- the external surface of the leaf made of waterproof plywood
- internal structure of the leaf in the form of a truss with a polyurethane foam filling
- the leaf tiles made of wood reinforced with sheet metal and a "C" profile

Standard set:

- thickness: 72 mm
- two independent bolt locks
- four hinges adjustable in three planes
- glazing package REFLEX BRONZE
- an aluminium threshold with a thermal separator or a wooden threshold



P141

DOOR THICKNESS

- ◀ 72 ▶
- ◀ 82 ▶
- ◀ 102 ▶

TYPE



FINISHING



STANDARD STRAIGHT OAK



KNOTTY OAK¹⁾

¹⁾ additional charge. The grain direction can be vertical or horizontal



NATURAL OAK¹⁾



DARK OAK



TEAK



WALNUT



WHITE



WINCHESTER



GOLDEN OAK



MAHOGANY



ROSEWOOD



RAL 7016



RAL COLOUR RANGE²⁾

¹⁾ additional charge. Available with plain or shallow-milled door

²⁾ additional charge



P82



P140



P141



P84



P53



P41

NON-REBATED DOORS - a additional charge applicable to the 82 and 102 mm-thick rebated doors.
Lacquered glass is only available on one side on the outside.

The ERKADO doors are available in non-standard dimensions **without an extra charge** for non-standard dimensions. The additional charge only applies to the following doors: higher than 212 cm and wider than 102 cm.



P83



P79



P138



P67

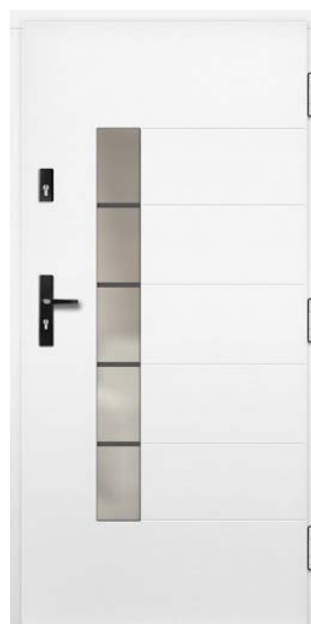

P119



P157

Knotty grain for an extra charge

NON-REBATED DOORS - a additional charge applicable to the 82 and 102 mm-thick rebated doors.

Lacquered glass is only available on one side on the outside.

The ERKADO doors are available in non-standard dimensions **without an extra charge** for non-standard dimensions. The additional charge only applies to the following doors: higher than 212 cm and wider than 102 cm.





P55



P94



P26



¹⁾ additional charge. Available with plain or shallow-milled door

²⁾ additional charge

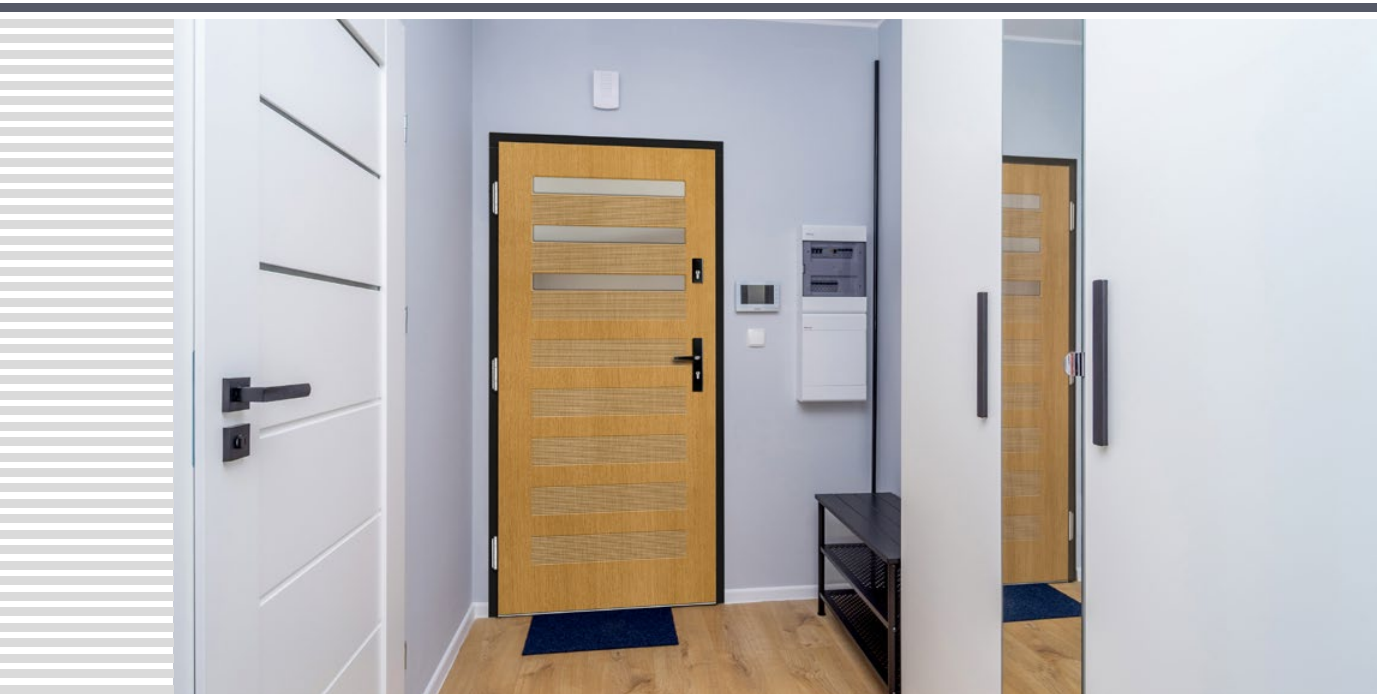

NON-REBATED DOORS - a additional charge applicable to the 82 and 102 mm-thick rebated doors.
Lacquered glass is only available on one side on the outside.

The ERKADO doors are available in non-standard dimensions **without an extra charge** for non-standard dimensions. The additional charge only applies to the following doors: higher than 212 cm and wider than 102 cm.



P151



P24



P25



P40



P118



P174

NON-REBATED DOORS - a additional charge applicable to the 82 and 102 mm-thick rebated doors.
Lacquered glass is only available on one side on the outside.

The ERKADO doors are available in non-standard dimensions **without an extra charge** for non-standard dimensions. The additional charge only applies to the following doors: higher than 212 cm and wider than 102 cm.





P71



P7



P142



¹⁾ additional charge. Available with plain or shallow-milled door

²⁾ additional charge



NON-REBATED DOORS - a additional charge applicable to the 82 and 102 mm-thick rebated doors.
Lacquered glass is only available on one side on the outside.

The ERKADO doors are available in non-standard dimensions **without an extra charge** for non-standard dimensions. The additional charge only applies to the following doors: higher than 212 cm and wider than 102 cm.



P146



P27



P92



P74



P137



P69

NON-REBATED DOORS - a additional charge applicable to the 82 and 102 mm-thick rebated doors.
Lacquered glass is only available on one side on the outside.

The ERKADO doors are available in non-standard dimensions **without an extra charge** for non-standard dimensions. The additional charge only applies to the following doors: higher than 212 cm and wider than 102 cm.





P159



P160



P161



P162



P163



P164

NON-REBATED DOORS - a additional charge applicable to the 82 and 102 mm-thick rebated doors.
Lacquered glass is only available on one side on the outside.

The ERKADO doors are available in non-standard dimensions **without an extra charge** for non-standard dimensions. The additional charge only applies to the following doors:
higher than 212 cm and wider than 102 cm.



P50



P22



P34



¹⁾ additional charge. Available with plain or shallow-milled door

²⁾ additional charge



NON-REBATED DOORS - a additional charge applicable to the 82 and 102 mm-thick rebated doors.

Lacquered glass is only available on one side on the outside.

The ERKADO doors are available in non-standard dimensions **without an extra charge** for non-standard dimensions. The additional charge only applies to the following doors: higher than 212 cm and wider than 102 cm.





P75



P61



P76



P62



P73



P32

NON-REBATED DOORS - a additional charge applicable to the 82 and 102 mm-thick rebated doors.
Lacquered glass is only available on one side on the outside.

The ERKADO doors are available in non-standard dimensions **without an extra charge** for non-standard dimensions. The additional charge only applies to the following doors: higher than 212 cm and wider than 102 cm.



P139



P77



P93



P80



P78



P148

NON-REBATED DOORS - a additional charge applicable to the 82 and 102 mm-thick rebated doors.
Lacquered glass is only available on one side on the outside.

The ERKADO doors are available in non-standard dimensions **without an extra charge** for non-standard dimensions. The additional charge only applies to the following doors: higher than 212 cm and wider than 102 cm.





P8



P9



P28



P47



P37



P72

NON-REBATED DOORS - a additional charge applicable to the 82 and 102 mm-thick rebated doors.
Lacquered glass is only available on one side on the outside.

The ERKADO doors are available in non-standard dimensions **without an extra charge** for non-standard dimensions. The additional charge only applies to the following doors: higher than 212 cm and wider than 102 cm.



P107



P108



P109



P20



P21

Stained glass an additional charge



P10

NON-REBATED DOORS - a additional charge applicable to the 82 and 102 mm-thick rebated doors.
Lacquered glass is only available on one side on the outside.

The ERKADO doors are available in non-standard dimensions **without an extra charge** for non-standard dimensions. The additional charge only applies to the following doors: higher than 212 cm and wider than 102 cm.





P145



P147



P149



P59



P110

Knotty grain for an extra charge



P18

NON-REBATED DOORS - a additional charge applicable to the 82 and 102 mm-thick rebated doors.
Lacquered glass is only available on one side on the outside.

The ERKADO doors are available in non-standard dimensions **without an extra charge** for non-standard dimensions. The additional charge only applies to the following doors:
higher than 212 cm and wider than 102 cm.

The CLASSIC door line is designed for classic houses. The characteristic feature of this line is its traditional and timeless design

Finishing material:

- meranti, oak or pine

Design:

- a gasket in the leaf and the frame
- a burglary-proof rebate on the hinges side
- the external surface of the leaf made of waterproof plywood
- internal structure of the leaf in the form of a truss with a polyurethane foam filling
- the leaf tiles made of wood reinforced with sheet metal and a "C" profile

Standard set:

- thickness: 72 mm
- two independent bolt locks
- four hinges adjustable in three planes
- glazing package REFLEX BRONZE
- an aluminium threshold with a thermal separator or a wooden threshold



P52

DOOR THICKNESS

- ◀72▶ ◀82▶ ◀102▶

TYPE



FINISHING

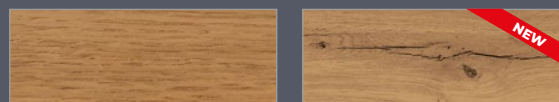

STANDARD STRAIGHT OAK

KNOTTY OAK¹⁾

¹⁾ additional charge. The grain direction can be vertical or horizontal

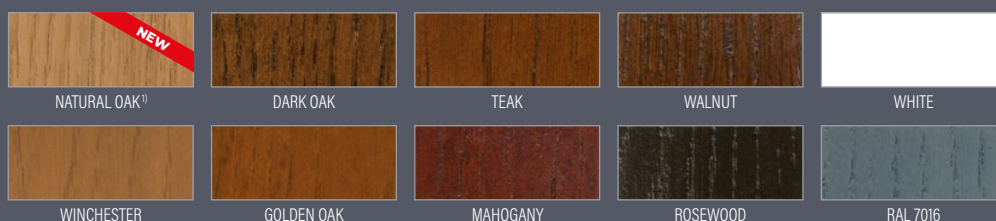

¹⁾ additional charge. Available with plain or shallow-milled door
²⁾ additional charge





P96



P17



P1



P38



P2



P35

NON-REBATED DOORS - a additional charge applicable to the 82 and 102 mm-thick rebated doors.
Lacquered glass is only available on one side on the outside.

The ERKADO doors are available in non-standard dimensions **without an extra charge** for non-standard dimensions. The additional charge only applies to the following doors:
higher than 212 cm and wider than 102 cm.



P15



P11



P29



¹⁾ additional charge. Available with plain or shallow-milled door

²⁾ additional charge



NON-REBATED DOORS - a additional charge applicable to the 82 and 102 mm-thick rebated doors.

Lacquered glass is only available on one side on the outside.

The ERKADO doors are available in non-standard dimensions **without an extra charge** for non-standard dimensions. The additional charge only applies to the following doors: higher than 212 cm and wider than 102 cm.



P5



P3



P45



P19



P33



P16

NON-REBATED DOORS - a additional charge applicable to the 82 and 102 mm-thick rebated doors.
Lacquered glass is only available on one side on the outside.

The ERKADO doors are available in non-standard dimensions **without an extra charge** for non-standard dimensions. The additional charge only applies to the following doors:
higher than 212 cm and wider than 102 cm.



P4

Stained glass additional charge



P117



P115

Stained glass additional charge



¹⁾ additional charge. Available with plain or shallow-milled door

²⁾ additional charge



NON-REBATED DOORS - a additional charge applicable to the 82 and 102 mm-thick rebated doors.

Lacquered glass is only available on one side on the outside.

The ERKADO doors are available in non-standard dimensions **without an extra charge** for non-standard dimensions. The additional charge only applies to the following doors: higher than 212 cm and wider than 102 cm.





P36



P113



P114

Stained glass additional charge



P31



P54



P13

Stained glass additional charge

NON-REBATED DOORS - a additional charge applicable to the 82 and 102 mm-thick rebated doors.
Lacquered glass is only available on one side on the outside.

The ERKADO doors are available in non-standard dimensions **without an extra charge** for non-standard dimensions. The additional charge only applies to the following doors: higher than 212 cm and wider than 102 cm.



P12



P6



P14



P116



P112



P111

NON-REBATED DOORS - a additional charge applicable to the 82 and 102 mm-thick rebated doors.
Lacquered glass is only available on one side on the outside.

The ERKADO doors are available in non-standard dimensions **without an extra charge** for non-standard dimensions. The additional charge only applies to the following doors: higher than 212 cm and wider than 102 cm.





P165



P166



P167

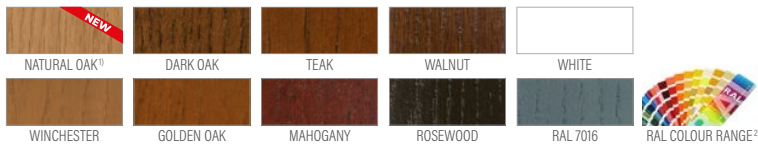

¹⁾ additional charge. Available with plain or shallow-milled door
²⁾ additional charge



NON-REBATED DOORS - a additional charge applicable to the 82 and 102 mm-thick rebated doors.
 Lacquered glass is only available on one side on the outside.

The ERKADO doors are available in non-standard dimensions **without an extra charge** for non-standard dimensions. The additional charge only applies to the following doors: higher than 212 cm and wider than 102 cm.



P168



P169

Stained glass: a additional charge



P170

Stained glass: a additional charge



P171



P143



P144

NON-REBATED DOORS - a additional charge applicable to the 82 and 102 mm-thick rebated doors.

Lacquered glass is only available on one side on the outside.

The ERKADO doors are available in non-standard dimensions **without an extra charge** for non-standard dimensions. The additional charge only applies to the following doors: higher than 212 cm and wider than 102 cm.





P63



P49



P39



P65



P51



P172

NON-REBATED DOORS - a additional charge applicable to the 82 and 102 mm-thick rebated doors.
Lacquered glass is only available on one side on the outside.

The ERKADO doors are available in non-standard dimensions **without an extra charge** for non-standard dimensions. The additional charge only applies to the following doors: higher than 212 cm and wider than 102 cm.



P30



P52

Stained glass additional charge



P23

Stained glass additional charge



¹⁾ additional charge. Available with plain or shallow-milled door

²⁾ additional charge



NON-REBATED DOORS - a additional charge applicable to the 82 and 102 mm-thick rebated doors.

Lacquered glass is only available on one side on the outside.

The ERKADO doors are available in non-standard dimensions **without an extra charge** for non-standard dimensions. The additional charge only applies to the following doors: higher than 212 cm and wider than 102 cm.

Finishing:

- veneers on both sides
- glass and stainless steel decors on the external side of the leaf - ONE SIDE ONLY
- 2 types of veneer available: MASKAR EBONY, BLACK AND WHITE EBONY
- the frame and rebate colour to be chosen from the Erkado colour range

Finishing material:

- meranti, oak

Design:

- a gasket in the leaf and the frame
- a burglary-proof rebate on the hinges side
- the external surface of the leaf made of waterproof plywood
- internal structure of the leaf in the form of a truss with a polyurethane foam filling
- the leaf tiles made of wood reinforced with sheet metal and a "C" profile

Standard set:

- multipoint lock for 1 insert, 72 mm spacing
- four hinges adjustable in three planes
- glazing package REFLEX BRONZE
- an aluminium threshold with a thermal separator or a wooden threshold

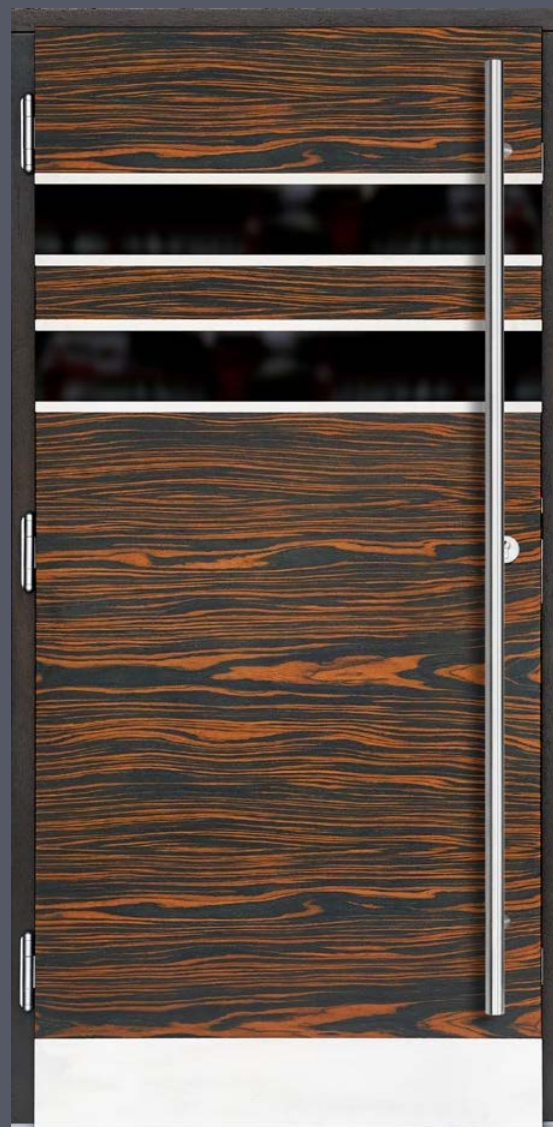

P88

DOOR THICKNESS

- ◀ 72 ▶ ◀ 82 ▶ ◀ 102 ▶

TYPE

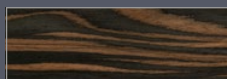

MASKAR EBONY

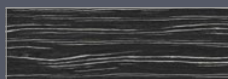

BLACK AND WHITE EBONY



P85



P86



P87



NON-REBATED DOORS - a additional charge applicable to the 82 and 102 mm-thick rebated doors.
Lacquered glass is only available on one side on the outside.

The ERKADO doors are available in non-standard dimensions **without an extra charge** for non-standard dimensions. The additional charge only applies to the following doors: higher than 212 cm and wider than 102 cm.

☰ FIXED GLAZED EXTENSIONS



WITH A GLASS FLUSH WITH THE LEAF SURFACE
(available only with flush doors)



P158



P154



P174
+ FIXED GLAZED EXTENSION IN THE FRAME



P163
+ FIXED GLAZED EXTENSIONS IN THE FRAME



P34
+ FIXED GLAZED EXTENSIONS (LEAF IMITATION)



P28
+ FIXED GLAZED EXTENSION (LEAF IMITATION)





P164
+ FIXED GLAZED EXTENSION



P162
+ FIXED GLASS EXTENSIONS





P169
+ FIXED GLAZED EXTENSION (LEAF IMITATION)



P170
+ FIXED GLAZED EXTENSIONS (LEAF IMITATION)



Note: the fixed extension imitating a door leaf is mounted on hinges.



P157
+ FIXED GLAZED EXTENSION IN THE FRAME



P152
+ FIXED GLAZED EXTENSION



P99
+ FIXED GLAZED EXTENSION (LEAF IMITATION)



P105
+ FIXED GLAZED EXTENSIONS IN THE FRAME



P156
+ FIXED GLAZED EXTENSION



P1
+ FIXED GLAZED EXTENSIONS IN THE FRAME



P153
+ FIXED GLAZED EXTENSION



P155
+ FIXED GLASS EXTENSIONS



P37
+ FIXED GLAZED EXTENSION (LEAF IMITATION)



P82
+ FIXED GLAZED EXTENSION (LEAF IMITATION)





P67
+ FIXED GLAZED EXTENSIONS (LEAF IMITATION)



P89
+ FIXED GLAZED EXTENSIONS (LEAF IMITATION)



P65
+ FIXED GLAZED EXTENSION (LEAF IMITATION)



P25
+ FIXED GLAZED EXTENSION (LEAF IMITATION)





P9
+ FIXED GLAZED EXTENSION (LEAF IMITATION)



P47
+ OPENABLE GLAZED EXTENSION



P21
+ FIXED GLAZED EXTENSION (LEAF IMITATION)



P55
+ FIXED GLAZED EXTENSION IN THE FRAME



P46
+ FIXED GLAZED EXTENSION IN THE FRAME



P137
+ FIXED GLAZED EXTENSIONS IN THE FRAME



P45
+ FIXED GLAZED EXTENSIONS IN THE FRAME



P59
+ FIXED FULL EXTENSION (LEAF IMITATION)

Note: extension fixed in the frame - glazing - safe, combined package, 44 mm, reflex brown

Note: the fixed extension imitating a door leaf is mounted on hinges.



P42
+ FIXED GLAZED EXTENSION (LEAF IMITATION) + FANLIGHT



P28
+ FIXED GLAZED EXTENSIONS (LEAF IMITATIONS) + FANLIGHT





P107
+ FIXED GLAZED EXTENSION IN THE FRAME



P132
+ FIXED GLAZED EXTENSION (LEAF IMITATION)



P147
+ FIXED GLAZED EXTENSIONS IN THE FRAME



P98
+ FIXED GLAZED EXTENSION (LEAF IMITATION)

Note: extension fixed in the frame - glazing - safe, combined package, 44 mm, reflex brown

Note: the fixed extension imitating a door leaf is mounted on hinges.





P68
+ FIXED GLAZED EXTENSION IN THE FRAME



P8
+ FIXED GLAZED EXTENSION (LEAF IMITATION)



P141
+ FIXED GLAZED EXTENSION (LEAF IMITATION)



P83
+ FIXED GLAZED EXTENSION (LEAF IMITATION)

Every house is fitted with interior doors. This is why thinking about doors from the perspective of their functional and practical features has long been insufficient. Underlining the best qualities in a perfectly furnished house, today they are an important component of interior design. For this reason, we create modern solutions, introduce attractive design and focus on the quality of workmanship to let you enjoy the choice of the Erkado doors.



LACQUER

- The wood used to make veneers differs in terms of colour, texture and consistency. Even a single tree may feature significant differences in this respect. These are the characteristic features of natural wood and may not be claimed.
- The presented colours are for illustrative purposes only and should not be used as colour samples.

FINISHING



STANDARD STRAIGHT OAK



KNOTTY OAK¹⁾



SMOOTH WHITE⁴⁾



NATURAL OAK¹⁾



DARK OAK



TEAK



WALNUT



WHITE⁴⁾



WINCHESTER



GOLDEN OAK



MAHOGANY



ROSEWOOD



RAL 7016⁴⁾



RAL COLOUR RANGE^{2) 4)}

¹⁾ additional charge. Available with plain or shallow-milled doors

²⁾ additional charge

³⁾ additional charge. Grain direction can be vertical or horizontal, for solid doors or doors with shallow millwork

⁴⁾ smooth or with a wood texture



Presented model: UNO PREMIUM with black matt CUBE Handle

UNO PREMIUM dark oak

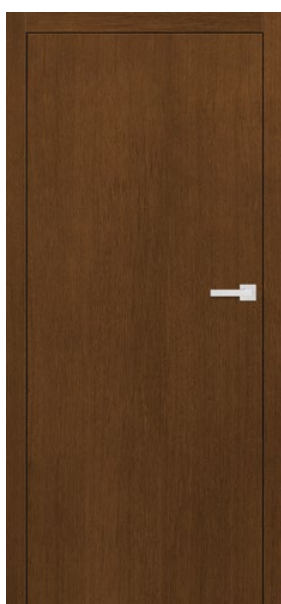

UNO PREMIUM natural oak



UNO PREMIUM white oak





UNO PREMIUM natural oak with a black matt CUBE handle

CONSTRUCTION

- non-rebated door leaf
- stile made of pine + oak wood reinforced with a "C" profile
- the outer surface of the door leaf is made of waterproof, 4 mm thick waterproof oak plywood or moisture-resistant 3 mm thick oak HDF for doors without a wood texture
- full panel filling
- leaf thickness 40 mm

FINISHING

- painted three times by means of the hydrodynamic method using water-soluble paints from the erkado colour range or ral opaque paints

HARDWARE

- three concealed silver hinges (optionally black, subject to a additional charge)
- with a magnetic lock, thumb turn cylinder, economy or with a blockade, silver; optionally, subject to additional charge, a black magnetic lock

ADDITIONAL CHARGES

- ventilation undercut
- non-rebated leaf "100"
- drop seal
- can be replaced with a black magnetic lock
- can be replaced with hinges and black catch plate
- door size 216-230 cm.....subject to a 15% additional charge
- door size 231-240 cm.....subject to a 25% additional charge
- door size 241-250 cm.....subject to a 30% additional charge

AVAILABLE DOOR LEAF WIDTHS

- 60
- 70
- 80
- 90
- 100
- MADE TO MEASURE

[UNO PREMIUM

FINISHING



STANDARD STRAIGHT OAK



KNOTTY OAK³⁾



SMOOTH WHITE
or another colour from the RAL range



NATURAL OAK¹⁾



DARK OAK



TEAK



WALNUT



WHITE⁴⁾



WINCHESTER



GOLDEN OAK



MAHOGANY



ROSEWOOD



RAL 7016⁴⁾



RAL COLOUR RANGE^{2) 4)}

¹⁾ additional charge. Available with plain or shallow-milled doors

²⁾ additional charge

³⁾ additional charge. Grain direction can be vertical or horizontal, for solid doors or doors with shallow millwork

⁴⁾ smooth or with a wood texture





BALDUR 1 with a CUBE PREMIUM handle and black VSG 441 laminated glass



BALDUR 1



BALDUR 2



BALDUR 3



BALDUR 4



BALDUR 5



BALDUR 6

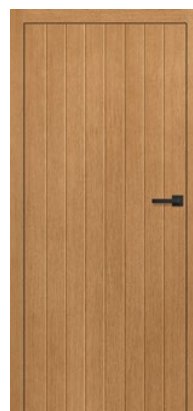

BALDUR 7

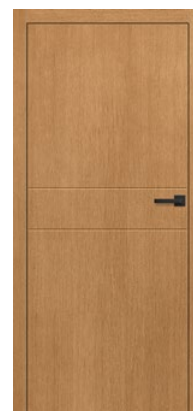

BALDUR 8



BALDUR 1 walnut with a CUBE handle, brushed chrome



CONSTRUCTION

- non-rebated door leaf
- stile made of pine + oak wood reinforced with a "C" profile
- the outer surface of the door leaf is made of waterproof, 4 mm thick waterproof oak plywood or moisture-resistant 3 mm thick oak HDF for doors without a wood texture
- full panel filling
- leaf thickness 40 mm

FINISHING

- painted three times by means of the hydrodynamic method using water-soluble paints from the erkado colour range or ral opaque paints

HARDWARE

- three concealed silver hinges (optionally black, subject to a additional charge)
- with a magnetic lock, thumb turn cylinder, economy or with a blockade, silver; optionally, subject to additional charge, a black magnetic lock

GLAZING

- BALDUR 1, 3, 5: VSG/ESG 441 laminated and tempered glass as standard, frosted or black, plain on both sides
- fixed glazing widths: BALDUR 1 – 50 mm, BALDUR 3, 5 – 210 mm

ADDITIONAL CHARGES

- ventilation undercut
- non-rebated leaf "100"
- Drop down seal (not in BALDUR 1, 3, 5)
- can be replaced with a black magnetic lock
- can be replaced with hinges and black catch plate
- door size 216-230 cm.....subject to a 15% additional charge
- door size 231-240 cm.....subject to a 25% additional charge
- door size 241-250 cm.....subject to a 30% additional charge

BALDUR

VENTILATION CUT



AVAILABLE DOOR LEAF WIDTHS



MOULDING

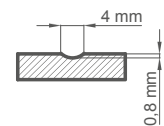

FINISHING

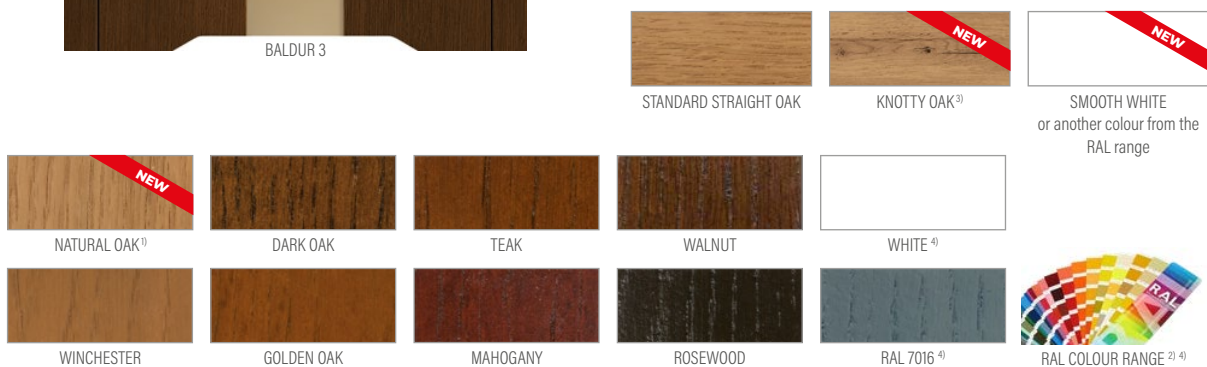

¹⁾ additional charge. Available with plain or shallow-milled doors
²⁾ additional charge
³⁾ additional charge. Grain direction can be vertical or horizontal, for solid doors or doors with shallow millwork
⁴⁾ smooth or with a wood texture



MISKANT 2, BELLA slim black matt handle



MISKANT 1

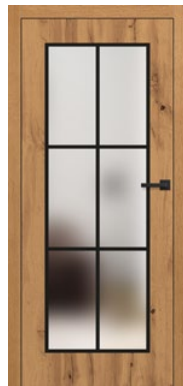

MISKANT 2

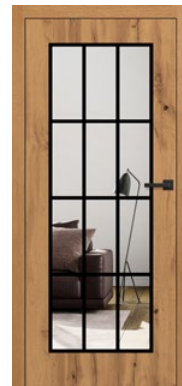

MISKANT 3



MISKANT 4



MISKANT 5



MISKANT 6



MISKANT 2, BELLA slim black matt handle

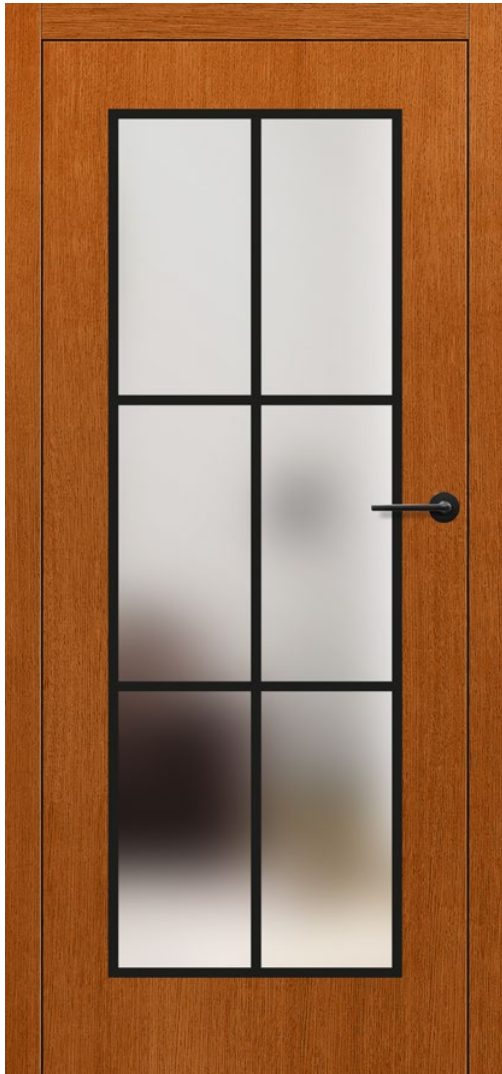

CONSTRUCTION

- non-rebated door leaf
- stile made of pine + oak wood reinforced with a "C" profile
- the outer surface of the door leaf is made of waterproof, 4 mm thick waterproof oak plywood or moisture-resistant 3 mm thick oak HDF for doors without a wood texture
- full panel filling
- leaf thickness 40 mm

FINISHING

- painted three times by means of the hydrodynamic method using water-soluble paints from the erkado colour range or ral opaque paints

HARDWARE

- three concealed silver hinges (optionally black, subject to a additional charge)
- with a magnetic lock, thumb turn cylinder, economy or with a blockade, silver; optionally, subject to additional charge, a black magnetic lock

GLAZING

- safety glass packet milky or transparent (single-chamber) gr. 30 mm
- possibility to change the glazing side to REVERSE (OBVERSE - standard glazing)
- black lines of 18 mm in width (thickness)

ADDITIONAL CHARGES











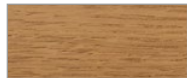

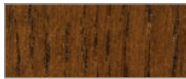

- ventilation undercut
- non-rebated leaf "100"
- drop seal
- can be replaced with a black magnetic lock
- can be replaced with hinges and black catch plate
- door size 216-230.....15% additional charge on the basic price
- door size 231-240 cm.....subject to a 25% additional charge
- door size 241-250 cm.....subject to a 30% additional charge

MISKANT

AVAILABLE DOOR LEAF WIDTHS

- 60 70 80 90 100 **MADE TO MEASURE**

FINISHING

 STANDARD STRAIGHT OAK	 KNOTTY OAK ³⁾	 SMOOTH WHITE or another colour from the RAL range
 NATURAL OAK ¹⁾	 DARK OAK	 TEAK
 WINCHESTER	 GOLDEN OAK	 MAHOGANY
 WALNUT	 WHITE ⁴⁾	 ROSEWOOD
 RAL 7016 ⁴⁾	 RAL COLOUR RANGE ^{2) 4)}	

¹⁾ additional charge. Available with plain or shallow-milled doors

²⁾ additional charge

³⁾ additional charge. Grain direction can be vertical or horizontal, for solid doors or doors with shallow millwork

⁴⁾ smooth or with a wood texture



TURAN 3, handle: BELLA slim, shiny brass



TURAN 1



TURAN 2

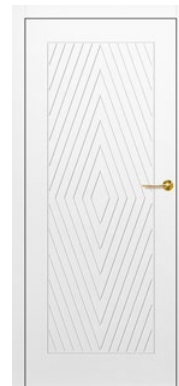

TURAN 3



TURAN 4



TURAN 5



TURAN 6



TURAN 5 painted RAL7016 with BELLA slim handle, chrome glossy



CONSTRUCTION

- non-rebated door leaf
- stile made of pine + oak wood reinforced with a "C" profile
- the outer surface of the door leaf is made of waterproof, 4 mm thick waterproof oak plywood or moisture-resistant 3 mm thick oak HDF for doors without a wood texture
- full panel filling
- leaf thickness 40 mm

FINISHING

- painted three times by means of the hydrodynamic method using water-soluble paints from the erkado colour range or ral opaque paints

HARDWARE

- three concealed silver hinges (optionally black, subject to a additional charge)
- with a magnetic lock, thumb turn cylinder, economy or with a blockade, silver; optionally, subject to additional charge, a black magnetic lock

GLAZING

- TURAN 1 safety glass packet milky or transparent or black (single chamber)gr. 30 mm

ADDITIONAL CHARGES

- ventilation undercut
- non-rebated leaf "100"
- drop seal
- can be replaced with a black magnetic lock
- can be replaced with hinges and black catch plate
- door size 216-230.....15% additional charge on the basic price
- door size 231-240 cm.....subject to a 25% additional charge
- door size 241-250 cm.....subject to a 30% additional charge

TURAN



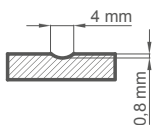









MOULDING



AVAILABLE DOOR LEAF WIDTHS

- 60 70 80 90 100 **MADE TO MEASURE**

FINISHING

					
NATURAL OAK ¹⁾	DARK OAK	TEAK	WALNUT	WHITE ⁴⁾	SMOOTH WHITE or another colour from the RAL range
					
WINCHESTER	GOLDEN OAK	MAHOGANY	ROSEWOOD	RAL 7016 ⁴⁾	RAL COLOUR RANGE ^{2) 4)}

¹⁾ additional charge. Available with plain or shallow-milled doors

²⁾ additional charge

³⁾ additional charge. Grain direction can be vertical or horizontal, for solid doors or doors with shallow millwork

⁴⁾ smooth or with a wood texture



MILDA 4, CUBE PREMIUM handle, black

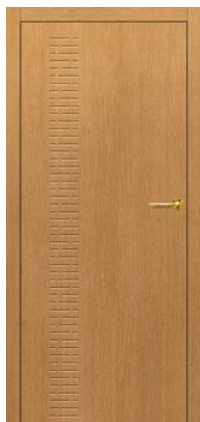

MILDA 1

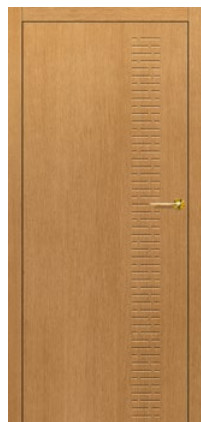

MILDA 2

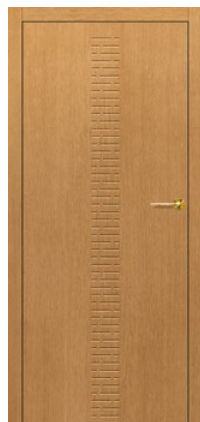

MILDA 3

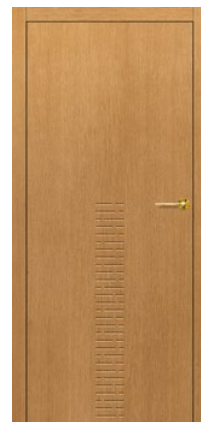

MILDA 4



MILDA 5



MILDA 2, handle: BELLA slim, shiny brass



CONSTRUCTION

- non-rebated door leaf
- stile made of pine + oak wood reinforced with a "C" profile
- the outer surface of the door leaf is made of waterproof, 4 mm thick waterproof oak plywood or moisture-resistant 3 mm thick oak HDF for doors without a wood texture
- full panel filling
- leaf thickness 40 mm

FINISHING

- painted three times by means of the hydrodynamic method using water-soluble paints from the erkado colour range or ral opaque paints

HARDWARE

- three concealed silver hinges (optionally black, subject to a additional charge)
- with a magnetic lock, thumb turn cylinder, economy or with a blockade, silver; optionally, subject to additional charge, a black magnetic lock

ADDITIONAL CHARGES

- ventilation undercut
- non-rebated leaf "100"
- drop seal
- can be replaced with a black magnetic lock
- can be replaced with hinges and black catch plate
- door size 216-230.....15% additional charge on the basic price
- door size 231-240 cm.....subject to a 25% additional charge
- door size 241-250 cm.....subject to a 30% additional charge

MILDA

MOULDING

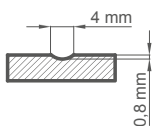

NATURAL OAK¹⁾



DARK OAK



TEAK



WALNUT



WHITE⁴⁾



WINCHESTER



GOLDEN OAK



MAHOGANY



ROSEWOOD



RAL 7016⁴⁾



RAL COLOUR RANGE^{2) 4)}

AVAILABLE DOOR LEAF WIDTHS

- 60 70 80 90 100 MADE TO MEASURE

FINISHING



STANDARD STRAIGHT OAK



KNOTTY OAK³⁾



SMOOTH WHITE or another colour from the RAL range

¹⁾ additional charge. Available with plain or shallow-milled doors

²⁾ additional charge

³⁾ additional charge. Grain direction can be vertical or horizontal, for solid doors or doors with shallow millwork

⁴⁾ smooth or with a wood texture





ANUBIS 2, handle: BELLA slim, shiny brass



ANUBIS 1



ANUBIS 2



ANUBIS 3

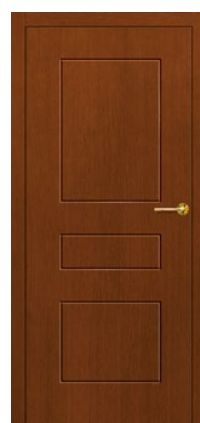

ANUBIS 4



ANUBIS 5



ANUBIS 3, mahogany, handle: BELLA slim, shiny brass



CONSTRUCTION

- non-rebated door leaf
- stile made of pine + oak wood reinforced with a "C" profile
- the outer surface of the door leaf is made of waterproof, 4 mm thick waterproof oak plywood or moisture-resistant 3 mm thick oak HDF for doors without a wood texture
- full panel filling
- leaf thickness 40 mm

FINISHING

- painted three times by means of the hydrodynamic method using water-soluble paints from the erkado colour range or ral opaque paints

HARDWARE

- three concealed silver hinges (optionally black, subject to a additional charge)
- with a magnetic lock, thumb turn cylinder, economy or with a blockade, silver; optionally, subject to additional charge, a black magnetic lock

ADDITIONAL CHARGES

- ventilation undercut
- non-rebated leaf "100"
- drop seal
- can be replaced with a black magnetic lock
- can be replaced with hinges and black catch plate
- door size 216-230.....15% additional charge on the basic price
- door size 231-240 cm.....subject to a 25% additional charge
- door size 241-250 cm.....subject to a 30% additional charge

ANUBIS



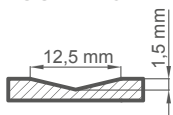







MOULDING



AVAILABLE DOOR LEAF WIDTHS

- 60 70 80 90 100 MADE TO MEASURE

FINISHING

				
NATURAL OAK ¹⁾	DARK OAK	TEAK	WALNUT	WHITE ⁴⁾
				
WINCHESTER	GOLDEN OAK	MAHOGANY	ROSEWOOD	RAL 7016 ⁴⁾

 RAL COLOUR RANGE^{2) 4)}

¹⁾ additional charge. Available with plain or shallow-milled doors

²⁾ additional charge

³⁾ additional charge. Grain direction can be vertical or horizontal, for solid doors or doors with shallow millwork

⁴⁾ smooth or with a wood texture





SYLENA 2, CUBE handle, black, matt



SYLENA 1



SYLENA 2



SYLENA 3



SYLENA 4



SYLENA 5



SYLENA 6



SYLENA 7



SYLENA 8



SYLENA 7, handle: BELLA slim, shiny brass

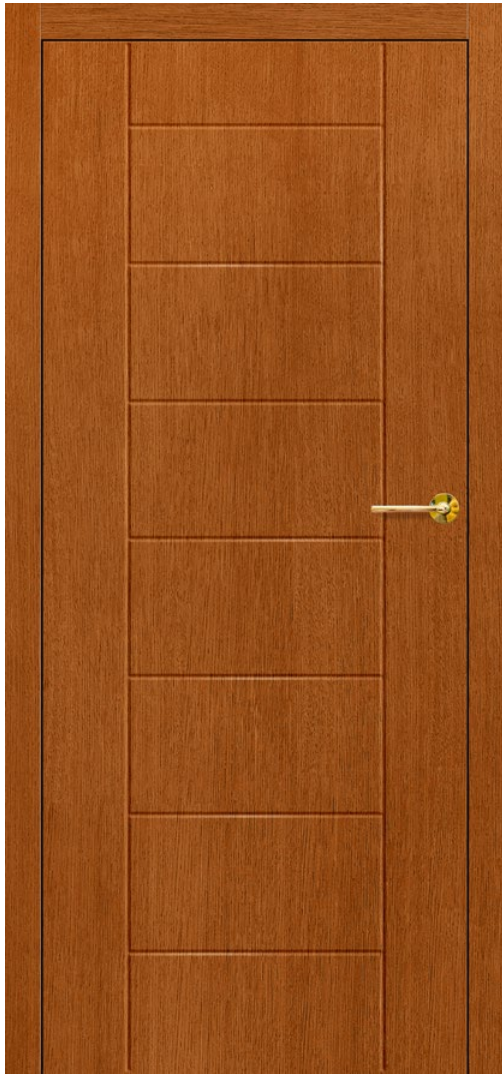

CONSTRUCTION

- non-rebated door leaf
- stile made of pine + oak wood reinforced with a "C" profile
- the outer surface of the door leaf is made of waterproof, 4 mm thick waterproof oak plywood or moisture-resistant 3 mm thick oak HDF for doors without a wood texture
- full panel filling
- leaf thickness 40 mm

FINISHING

- painted three times by means of the hydrodynamic method using water-soluble paints from the erkado colour range or ral opaque paints

HARDWARE

- three concealed silver hinges (optionally black, subject to a additional charge)
- with a magnetic lock, thumb turn cylinder, economy or with a blockade, silver; optionally, subject to additional charge, a black magnetic lock

ADDITIONAL CHARGES

- ventilation undercut
- non-rebated leaf "100"
- drop seal
- can be replaced with a black magnetic lock
- can be replaced with hinges and black catch plate
- door size 216-230.....15% additional charge on the basic price
- door size 231-240 cm.....subject to a 25% additional charge
- door size 241-250 cm.....subject to a 30% additional charge

SYLENA

MOULDING

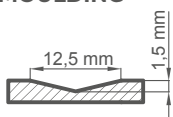

AVAILABLE DOOR LEAF WIDTHS

- 60 70 80 90 100 **MADE TO MEASURE**

FINISHING

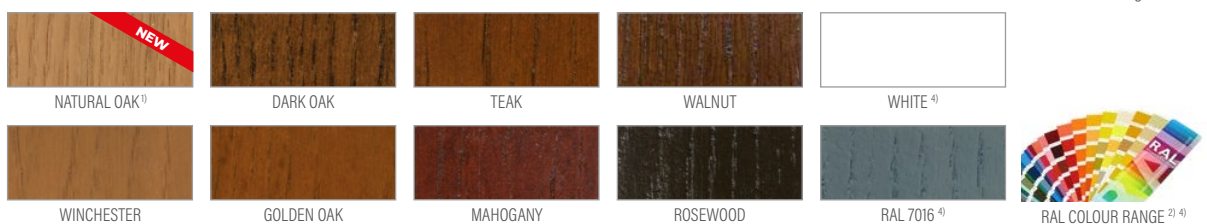

¹⁾ additional charge. Available with plain or shallow-milled doors

²⁾ additional charge

³⁾ additional charge. Grain direction can be vertical or horizontal, for solid doors or doors with shallow millwork

⁴⁾ smooth or with a wood texture



LOFT 1 natural oak, BELLA handle slim chrome glossy



LOFT 1



LOFT 2



LOFT 3

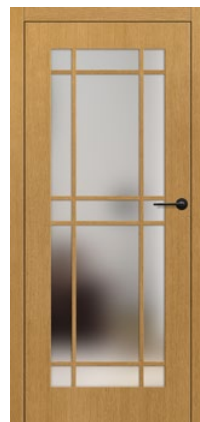

LOFT 4

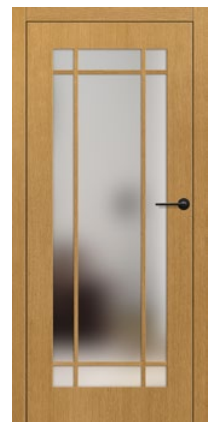

LOFT 5



LOFT 5, handle: BELLA slim, shiny brass



CONSTRUCTION

- non-rebated door leaf
- stile made of pine + oak wood reinforced with a "C" profile
- the outer surface of the door leaf is made of waterproof, 4 mm thick waterproof oak plywood or moisture-resistant 3 mm thick oak HDF for doors without a wood texture
- full panel filling
- leaf thickness 40 mm

FINISHING

- painted three times by means of the hydrodynamic method using water-soluble paints from the erkado colour range or ral opaque paints
- double-sided muntin bar glued onto the glass, width: 2.5 cm

HARDWARE

- three concealed silver hinges (optionally black, subject to a additional charge)
- with a magnetic lock, thumb turn cylinder, economy or with a blockade, silver; optionally, subject to additional charge, a black magnetic lock

GLAZING

- safety glass package, milky or transparent (single-chamber) gr. 30 mm)

ADDITIONAL CHARGES











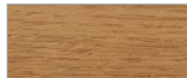

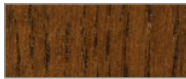

- ventilation undercut
- non-rebated leaf "100"
- drop seal
- can be replaced with a black magnetic lock
- can be replaced with hinges and black catch plate
- door size 216-230.....15% additional charge on the basic price
- door size 231-240 cm.....subject to a 25% additional charge
- door size 241-250 cm.....subject to a 30% additional charge

[LOFT

AVAILABLE DOOR LEAF WIDTHS

- 60 70 80 90 100 **MADE TO MEASURE**

FINISHING

 STANDARD STRAIGHT OAK	 KNOTTY OAK ³⁾	 SMOOTH WHITE or another colour from the RAL range			
 NATURAL OAK ¹⁾	 DARK OAK	 TEAK	 WALNUT	 WHITE ⁴⁾	
 WINCHESTER	 GOLDEN OAK	 MAHOGANY	 ROSEWOOD	 RAL 7016 ⁴⁾	 RAL COLOUR RANGE ^{2) 4)}

¹⁾ additional charge. Available with plain or shallow-milled doors

²⁾ additional charge

³⁾ additional charge. Grain direction can be vertical or horizontal, for solid doors or doors with shallow millwork

⁴⁾ smooth or with a wood texture

DOOR FRAMES AND INTERNAL DOOR HANDLES

ADJUSTABLE DOOR FRAME AND A TUNNEL

	Adjustment range min-max (mm)
	1 Component
100-120	
120-140	
140-160	
160-180	
180-200	
200-220	
220-240	
240-260	
260-280	
2 Components	260-300
	280-300
	300-320
	320-340
	340-360
	360-380
	380-400
	400-420

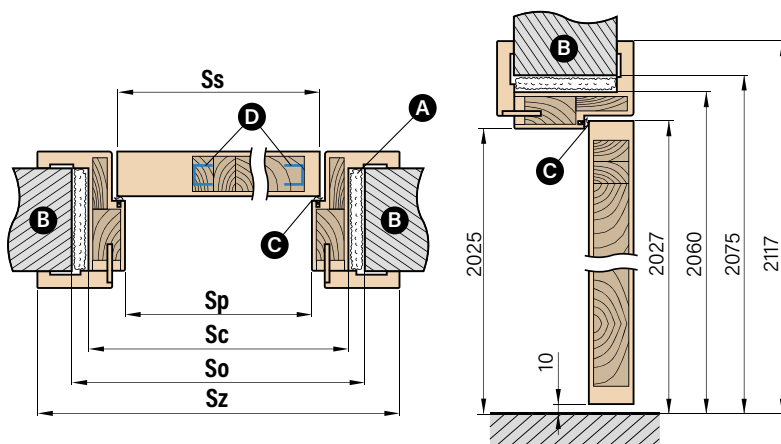

A - polyurethane foam B - wall C - seal D - U-iron

Door width	Ss	Sp	So	Sc	Sz
"60"	618	600	700	670	779
"70"	718	700	800	770	879
"80"	844	829	900	870	979
"90"	944	929	1000	970	1079
"100"	1044	1029	1100	1070	1179

- bands joined only at 90 degrees with an 8 cm band
- electric strike
- movable iron with 2 cm leaf extension and a standard angle for frames

- possibility to make door frames ranging between 500 and 520 mm - an additional charge for each 2 cm, relative to the frame price
- price of the tunnel frame included in the price of the non-rebated frame

HARDWARE



QUBIK handle

black matt, glossy chrome, white matt, velvet nickel



LUNA PREMIUM SQUARE handle

glossy chrome, brushed matt chrome, glossy brass, black matt



LUNA PREMIUM ROUND handle

glossy chrome, brushed matt chrome, glossy brass, black matt



BELLA SLIM SQUARE (prestige 6 mm faceplate)

glossy chrome, brushed matt chrome, glossy brass, black matt



CUBE handle (prestige 6 mm)

glossy chrome, brushed matt chrome, glossy brass, black matt



CUBE handle

glossy chrome, brushed matt chrome, brushed matt nickel, black matt



CUBE PREMIUM Handle

glossy chrome, brushed matt chrome, brushed matt nickel, black matt



BELLA SLIM ROUND handle (6 mm prestige faceplate)

glossy chrome, brushed matt chrome, glossy brass, black matt



Heat transfer coefficient

Ud < 0,90 W/m²K

Certificate No. ITB 831/B-2018-13

Material: oak, pine or meranti

Construction

- door leaf thickness 72 mm
- gasket in the leaf and frame
- rebated doors
- outer surface of the leaf made of 12 mm or 7 mm thick waterproof oak, pine or meranti plywood
- internal construction of the leaf in the form of a truss with polyurethane foam filling - 58 mm thick (7 mm plywood) and 48 mm thick (12 mm plywood)
- Leaf stile made of pine+oak or pine+meranti wood, reinforced with sheet metal and a "C" profile
- hinge-side anti-burglary rebate

Door frame

- glued laminated timber with oak, pine or meranti glulam 100 mm x 60 mm
- aluminium threshold with a thermal separator or wooden threshold

Finishing

- painted three times using the hydrodynamic method with water-soluble paints according to the ERKADO colour range or opaque RAL paints at an additional charge except RAL 9016 (white) and RAL 7016 (anthracite) (page 83)

Dimensions

- typical according to table (page 82)
- available in non-standard sizes at no additional charge for non-standard dimensions. An additional charge applies only to doors: higher than 212 cm and wider than 102 cm

Standard accessories

- 2 independent bolt locks, 72 mm spacing
- four hinges adjustable in three planes
- aluminium threshold with a thermal separator or wooden threshold
- decorative stainless steel sheets with selected models
- glazing package with black painted glass with selected models

Equipment subject to an additional charge

- | | |
|------------------|---|
| - handle | - electric strike - only for a multipoint lock for 1 or 2 cylinders |
| - 35/65 inserts | - multipoint lock for one or two cylinders |
| - grip | - wooden canopy (doors opening inwards) |
| - biometric lock | |
| - door viewer | |
| - reed switch | |

Cladded wooden threshold

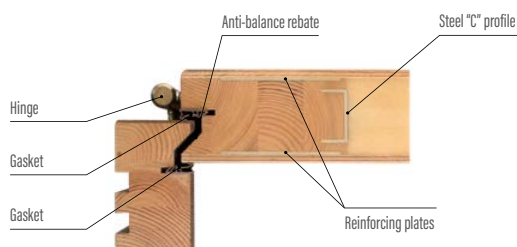
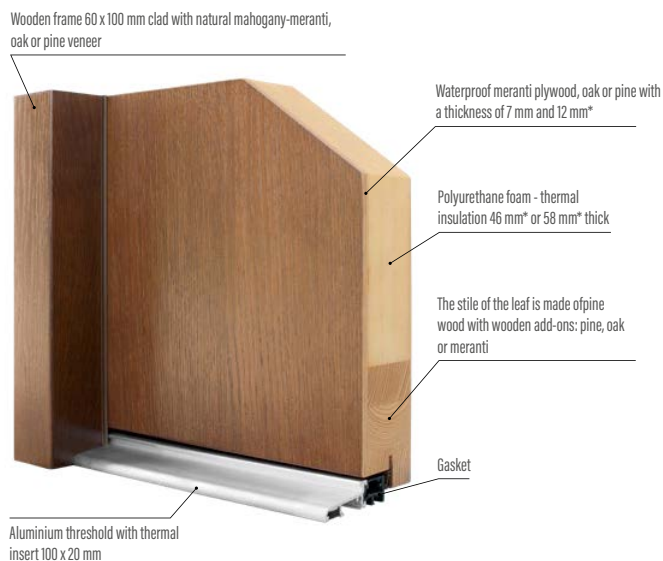



Heat transfer coefficient

Ud < 0,78 W/m²K

Certificate No. ITB 831/B-2018-14

Material: oak, pine or meranti

Construction

- door leaf thickness 82 mm
- gasket in the leaf and frame
- rebated doors
- outer plating made from waterproof 12 mm or 7 mm thick mahogany meranti, oak or pine plywood
- internal construction of the leaf in the form of a truss with polyurethane foam filling of 58 mm or 68 mm
- the stile of the frame made of pine+meranti or pine+oak wood, reinforced with sheet metal and a "C" profile
- hinge-side anti-burglary rebate

Door frame

- wood glued in layers with mahogany-meranti, oak or pine add-ons of 100 mm x 60 mm
- aluminium threshold with a thermal separator or wooden threshold

Finishing

- painted three times using the hydrodynamic method with water-soluble paints according to ERKADO colour range or opaque RAL paints at an additional charge except RAL 9016 (white) and RAL 7016 (anthracite) (page 83)

Dimensions

- typical according to table (page 82)
- available in non-standard sizes at no additional charge for non-standard dimensions. An additional charge applies only to doors: higher than 212 cm and wider than 102 cm

Standard accessories

- multipoint lock for 1 cylinder, 72 mm spacing
- four hinges adjustable in three planes
- aluminium threshold with a thermal separator or wooden threshold
- decorative, stainless steel plates in selected models:
- glazing package with black painted glass in models: P120, P121, P122, P123, P124, P125, P126, P127

Equipment subject to an additional charge

- handle
- 45/65 inserts
- grip
- biometric lock
- door viewer
- reed switch
- electric strike
- multipoint lock for two cylinders
- thermal insulation insert for threshold
- aluminium drip cap (doors opening inwards)

Cladded wooden threshold

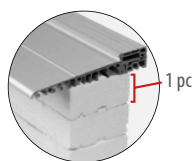

heat insulating insert H 30 mm x W 64 mm - for an additional charge

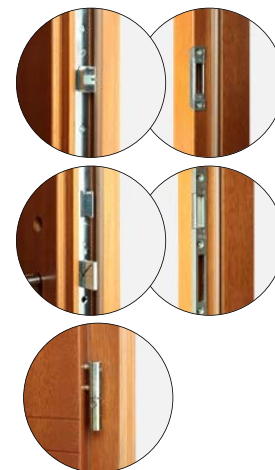
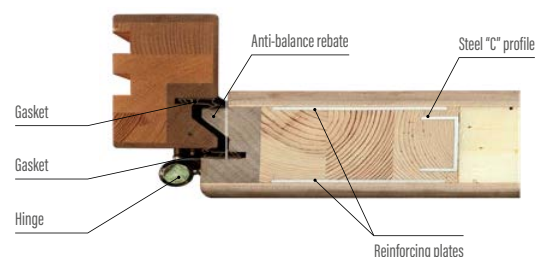
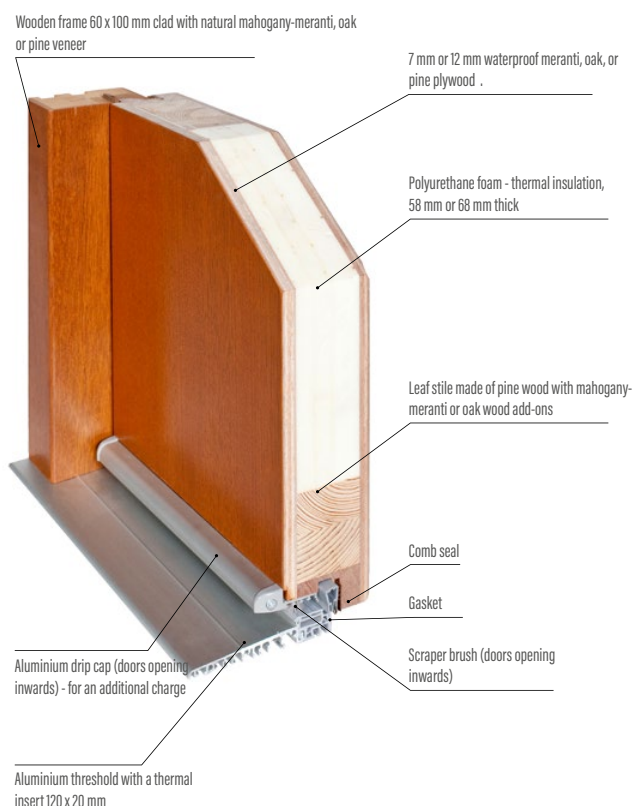

Heat transfer coefficient

$U_d < 0,63 \text{ W/m}^2\text{K}$

Certificate No. ITB 831/B-2018-15

Material: meranti or oak

Construction

- door leaf thickness 102 mm
- gasket in the leaf and frame
- rebated doors
- outer plating made of 12 mm thick waterproof mahogany meranti or oak plywood
- internal construction of the leaf in the form of a truss with polyurethane foam filling of 78 mm
- the stile of the frame made of pine+meranti or pine+oak wood, reinforced with sheet metal and a "C" profile
- hinge-side anti-burglary rebate

Door frame

- wood glued in layers with mahogany-meranti or oak add-ons of 100 mm x 80 mm
- aluminium threshold with a thermal separator or wooden threshold

Finishing

- painted three times using the hydrodynamic method with water-soluble paints according to ERKADO colour range or opaque RAL paints at an additional charge except RAL 9016 (white) and RAL 7016 (anthracite) (page 83)

Dimensions

- typical according to table (page 82)
- available in non-standard sizes at no extra charge for non-standard dimensions. The additional only applies to doors: higher than 214 cm and wider than 106 cm.

Standard accessories

- multipoint lock for 1 cylinder, 92 mm spacing
- hinges adjustable in three "3D" planes
- aluminium threshold with a thermal separator or wooden threshold
- decorative stainless steel sheets in selected models

Equipment subject to an additional charge

- handle
- 60/65 inserts
- grip
- biometric lock
- door viewer
- electric strike
- thermal insulation insert for threshold
- aluminium drip cap (doors opening inwards)
- reed switch

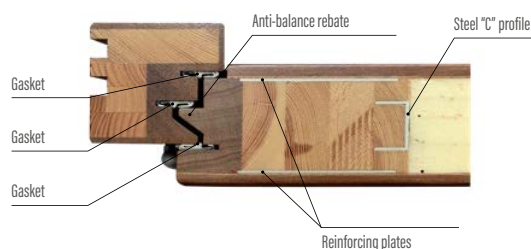
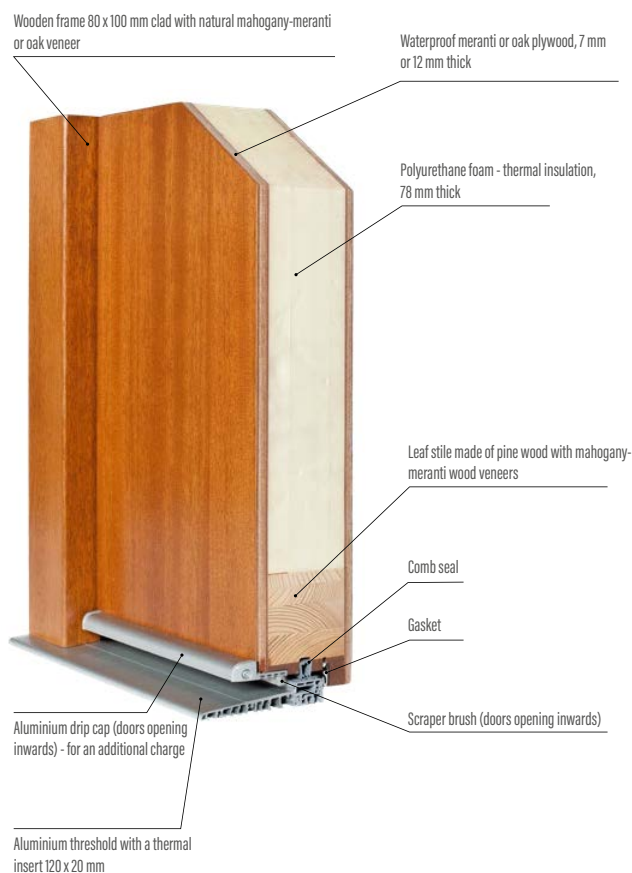

Cladded wooden threshold

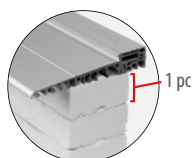

heat insulating insert H 30 mm x W 64 mm - for an additional charge

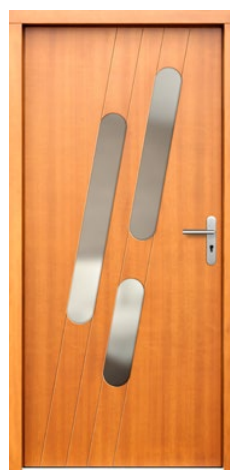

Heat transfer coefficient

$U_d < 0,64 \text{ W/m}^2\text{K}$

Certificate No. ITB 831/B-2018-16

Material: meranti or oak

Construction

- door leaf thickness 102 mm
- gasket in the leaf and frame
- non-rebated doors
- outer plating made of 12 mm thick waterproof mahogany meranti or oak plywood
- internal construction of the leaf in the form of a truss with polyurethane foam filling of 78 mm
- the stile of the frame made of pine+meranti or pine+oak wood, reinforced with sheet metal and a "C" profile
- three retractable hinges
- anti-burglary bolts

Door frame

- wood glued in layers with mahogany-meranti or oak add-ons of 107 mm x 80 mm
- wooden threshold

Finishing

- painted three times using the hydrodynamic method with water-soluble paints according to ERKADO colour range or opaque RAL paints at an additional charge except RAL 9016 (white) and RAL 7016 (anthracite) (page 83)

Dimensions

- typical according to table (page 82)
- available in non-standard sizes at no extra charge for non-standard dimensions. The additional charge only applies to the following doors: higher than 214 cm and wider than 106 cm.

Standard accessories

- multipoint lock for 1 cylinder, 72 mm spacing
- three "3D" three-plane retractable hinges
- aluminium threshold with a thermal separator or wooden threshold
- decorative stainless steel sheets in selected models
- glazing packet with black painted glass in selected models

Equipment subject to an additional charge

- | | |
|---------------------------------|--|
| - handle | - electric strike |
| - 55/70 inserts | - thermal insulation insert for threshold |
| - grip | - aluminium drip cap (doors opening inwards) |
| - biometric lock | - reed switch |
| - multipoint lock for 2 inserts | |
| - door viewer | |

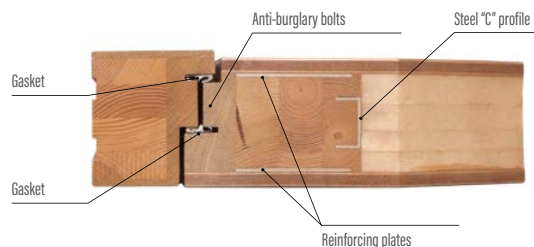
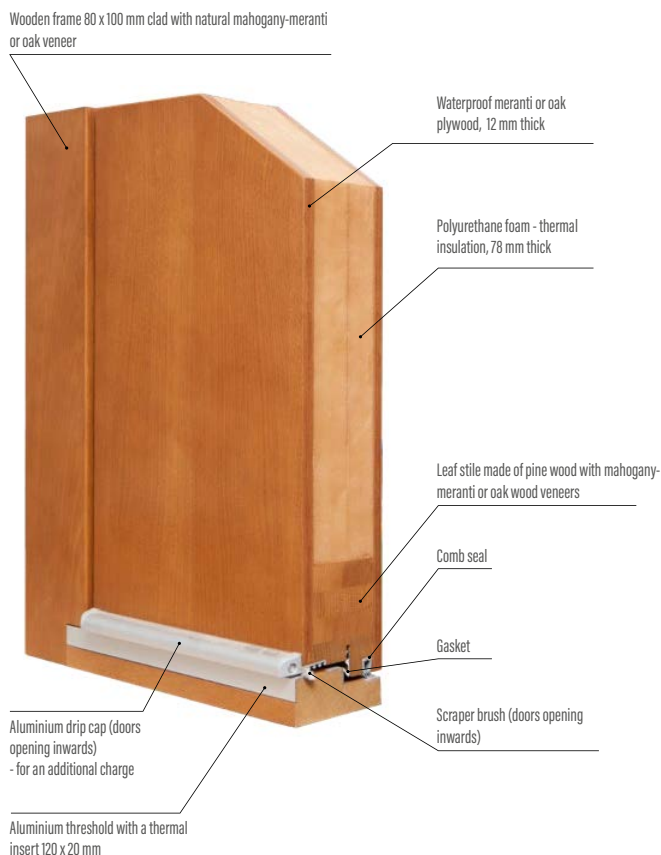



Revolving doors, a departure from the hinges on standard side fixings.

- the permissible leaf weight is up to 500 kg
- the permissible plane leaf dimensions: 150 cm x 250 cm, and for doors with glass and milling: 120 cm x 250 cm
- each door may be additionally enlarged by fixed glass or solid extensions in the frame
- the latest technology and hinge fixtures allow the highest quality of manufacture and use and lightweight opening, regardless of the weight of the leaf
- PIWOT DOOR prices are negotiated individually.



CO-FINANCING FOR EXTERNAL DOORS

The Priority Programme Clean Air gives the opportunity to obtain financial support for e.g. external doors. All ERKADO entrance door models meet the requirements of the Clean Air programme.

Below you can see the results of tests of thermal permeability of ERKADO external doors, as well as the RC2 certificate for burglar resistance.



TYPES OF GLAZING THAT CAN BE USED

ANTISOL

It is a solar control glass that is lightly tinted with a brown mass that reduces the transmission of solar energy. This prevents the rooms from overheating. Besides, it protects items sensitive to ultraviolet radiation.

REFLEX (stopsol)

It is a glass with enhanced solar control. Improving the visual effect and giving a sense of privacy. This effect is achieved by applying metal oxides to one side of the glass. Those on the lighter side of the mirror can see their reflection and are visible to those on the darker side. If a person on the lighter side gets very close to the glass, they can see objects on the darker side.

ONE-WAY MIRROR (phoenician)

It is a glass pane coated with metal oxide on both sides. Typically used as a partition between rooms, one of which is darkened. Those on the lighter side of the mirror can see their reflection and are visible to those on the darker side.

MILK GLASS

It is a glass covered on one side with satin-matt varnish, thanks to which it "lets" the light in, but becomes opaque.

P4 ANTI-BURGLARY

It consists of two layers of clear glass, between which there is an anti-burglary film. Thanks to the film, the glass does not fall into small pieces when broken. Radially spreading cracks form at the point of impact. P4 glass is only available as clear glass.

SAFETY GLASS 33.1

It is the one, which minimizes health hazard for people staying near glazing and in glazed rooms. Debris from broken glass, as well as fire, gases and thermal radiation - symptoms accompanying fires - can pose a danger. A glass is called "safety" if the technique of its manufacture or combination helps to limit damage from possible deformation, impact or fire.

The 33.1 marking indicated that 2 panes of 3 mm glass and one layer of a film were used. The 33.1 safety glass 33.1 belongs to the 02 glass class. It is most often used in flats, schools, offices. It provides protection against injury>It can also be used in buildings with an internal explosion hazard

SANDBLASTED GLASS

In the sandblasting process, the glass undergoes a mechanical tarnishing process using a high-pressure stream of sand. This process makes it possible to decorate the glass with any designs from our catalogues or patterns provided by the customer. You can get the effect of a matt pattern or, conversely, a translucent pattern.



SAFETY GLASS
SET 54 mm
with REFLEX glass



SAFETY GLASS
SET 70 mm
with REFLEX glass

Reflex brown glass as a standard. Changing the glazing to milk glass, sandblasted glass or one-way mirror, REFLEX GRAFIT, P4: fixed additional charge.





RABBET ON THE LEAF REBATE

advantages:

- tighter fit of the leaf to the frame
- full coverage of striker plates

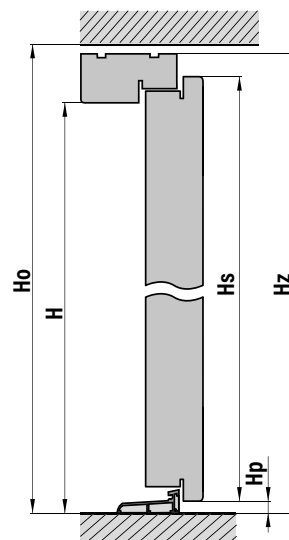
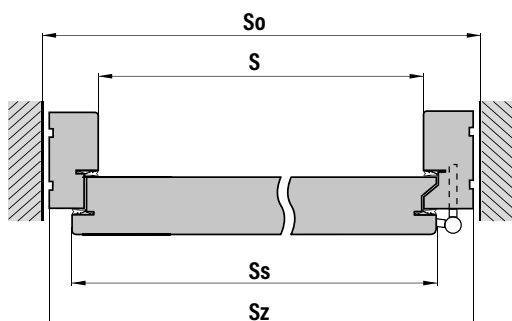

- S** - width in the clearance of door frame (mm)
- So** - opening width in the wall (mm)
- Ss** - door leaf width (mm)
- Sz** - total door width (mm)
- Ho** - height of the opening in the wall (mm)

- H** - height in the clearance of the door frame (mm)
- Hs** - door leaf height (mm)
- Hz** - total door height (mm)
- Hpa** - aluminium threshold height (mm)
- Hpd** - wooden threshold height (mm)

DIMENSIONS

ALUMINIUM THRESHOLD DOOR DIMENSIONS										
Door leaf thickness	Door marking	S	So	Ss	Sz	H	Ho	Hs	Hz	Hpa ALU (aluminium threshold)
72 mm thick 82 mm thick	"80"	800	940	841	920	2002	2100	2041	2082	20
	"90"	900	1040	941	1020	2002	2100	2041	2082	20
	"100"	1000	1140	1041	1120	2002	2100	2041	2082	20
102 mm thick	"80"	800	980	871	960	2002	2120	2056	2102	20
	"90"	900	1080	971	1060	2002	2120	2056	2102	20
	"100"	1000	1180	1071	1160	2002	2120	2056	2102	20

WOODEN THRESHOLD DOOR DIMENSIONS										
Door leaf thickness	Door marking	S	So	Ss	Sz	H	Ho	Hs	Hz	Hpd WOOD (wooden threshold)
72 mm thick 82 mm thick	"80"	800	940	841	920	2002	2120	2041	2100	40
	"90"	900	1040	941	1020	2002	2120	2041	2100	40
	"100"	1000	1140	1041	1120	2002	2120	2041	2100	40
102 mm thick	"80"	800	980	871	960	2002	2140	2056	2120	40
	"90"	900	1080	971	1060	2002	2140	2056	2120	40
	"100"	1000	1180	1071	1160	2002	2140	2056	2120	40

DOOR OPENING DIRECTIONS

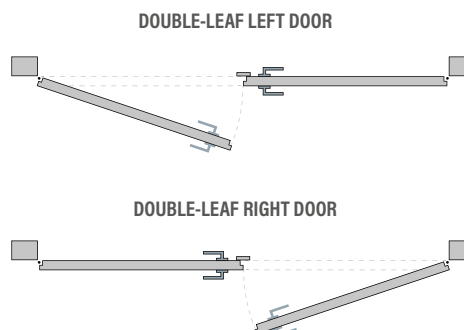
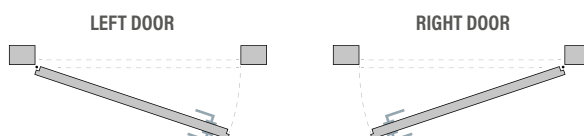



ADDITIONAL CHARGES FOR NON-STANDARD ORDERS

EXTERIOR DOORS



ADDITIONAL CHARGES FOR NON-STANDARD ORDERS	
Item	Description
1.	No additional charge for doors narrower than 102 cm and lower than 212 cm (thickness: 72 mm and 82 mm)
2.	additional charge for wider doors:
a)	Wider doors up to a total width of 106 cm (door thickness: 72 mm and 82 mm)
b)	Wider doors up to a total width of 110 cm (door thickness: 102 mm)
c)	Doors with an overall width of 107 cm to 111 cm (door thickness: 72 mm and 82 mm)
d)	Doors of overall width from 111 cm to 115 cm (door thickness: 102 mm)
e)	Additional charge for door size "100" (112 x 208.2/210 - door thickness: 72 mm and 82 mm), (116x210.2/212 - door thickness: 102 mm)
3.	additional charge for higher door (without fanlight):
a)	Ranging from 212 to 215 cm + 15% of a typical door
b)	Ranging from 215 to 224 cm + 30% of a typical door
c)	Ranging from 224 to 250 cm + 40% of a typical door
4.	Side extension for an overall door width of up to 150cm:
a)	Openable, with glazing + 75% of single door value
b)	Openable, without glazing + 70% of single door value
c)	Fixed leaf imitation without glazing + 50% of single door value
d)	Fixed glazed leaf imitation + 60% of single door value
e)	Fixed in the frame - mahogany-meranti (regardless of overall width)
f)	Fixed in frame - oak (regardless of total width)
g)	Fixed in the frame - pine (regardless of overall width)
5.	Side extension with overall door width from 151cm to 170cm:
a)	Openable, with glazing + 95% of single door value
b)	Openable, without glazing + 90% of single door value
c)	Fixed glazed leaf imitation + 85% of single door value
d)	Fixed leaf imitation without glazing + 80% of single door value
e)	Fixed in the frame - mahogany-meranti (regardless of overall width)
f)	Fixed in the frame - oak (regardless of overall width)
g)	Fixed in the frame - pine (regardless of the total width)
6.	additional charge for double doors from 171 to 196cm width is + 110% of single door value
7.	Frame fixed extensions and fanlight
a)	Fixed in frame - mahogany-meranti
b)	Fixed in the frame - oak (regardless of overall width)
c)	Fixed in the frame - pine (regardless of the total width)
d)	Fixed imitation door leaf up to total door height of 250cm + 50% of the door value
8.	ADDITIONAL CHARGES - COLOUR
a)	Colour from the RAL range (single door), except Ral 9016 (white) and Ral 7016 (anthracite)
b)	Double-colour doors
9.	additional charge for changing the glazing
a)	Fixed additional charge for changing the glazing e.g. one-way mirror, milk glass, sandblasted glass, P4, REFLEX GRAFIT, black REFLEX, ANTISOL black
10.	Frame thickness: for 10 mm/mb (pine, oak, meranti)
11.	Widening of the frame to the wall width in the form of a tunnel:
a)	material mahogany-meranti per cm adjustable mahogany-meranti headband
b)	material oak for every cm adjustable band oak
c)	material pine for every cm adjustable band pine
12.	Covering bands 10 mm x 60 mm set per side
a)	mahogany-meranti
b)	oak
c)	pine
13.	Quarter rounds 10 mm x 25 mm set for one side (set)
a)	mahogany - meranti
b)	oak
c)	pine
14.	Aluminium drip cap for doors opening to the inside
a)	Wooden drip cap for inward opening doors
15.	Fixed glazed extension with glass flush with the leaf (only available for non-rebated doors)





DOOR VIEWER



WIDENING OF DOOR FRAMES



METAL CAPS FOR HINGES



AXA aluminium caps

caps for four hinges (set) aluminium Metal Bud (nickel, patina)
caps for four hinges (set) aluminium AXA (inox, F1, F4) or steel TKZ

LOCKS

GU SECURITY AUTOMATIC OR MR 2 MULTIPOINT LOCK

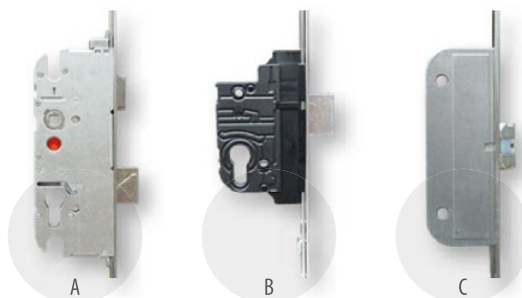

When using a multipoint lock, the door meets the requirements of the 2 RC2 burglary resistance class

MULTIPOINT LOCK

FOR ONE INSERT:
thickness 82 mm and 102 mm - standard
thickness 72 mm - an additional charge

MULTIPOINT LOCK

FOR TWO INSERTS:
thickness 82 mm - an additional charge
thickness 72 mm - an additional charge



TKZ HINGE

patina, nickel or black
thickness 102 mm - standard
thickness 72 mm and 82 mm

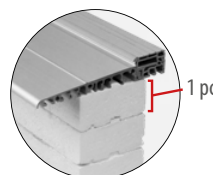

HEAT INSULATING INSERT

height 30 mm x W 64 mm - for an additional charge

REED SWITCH



POWER SUPPLY



TKZ CAP STEEL chrome polished

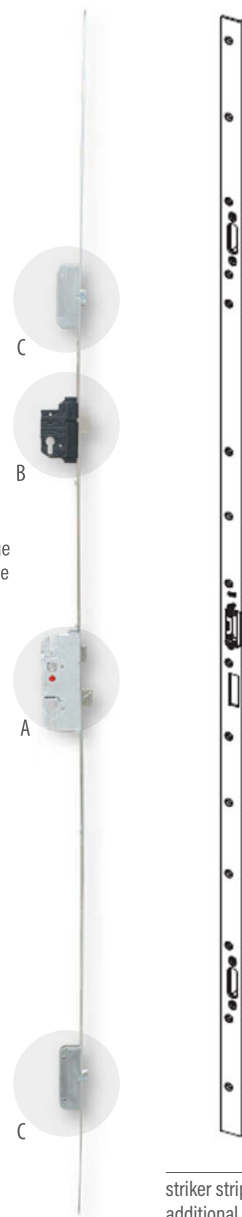

striker strip for an additional charge

DOOR CLOSER



Retractable DOOR CLOSER with a STOP function and a restrictor



ARM DOOR CLOSER

ELECTRIC DOOR STRIKE



ELECTRIC DOOR STRIKE is available only with a multipoint lock for 1 or 2 inserts

DOOR CARE PRODUCT



Regular maintenance of wooden windows and doors is important for long-term durability of their surface. To keep the costs as low as possible, ADLER has developed a maintenance kit that is simple and effective to use. No brush, no sandpaper needed, just a care kit. The micro cracks and micro pores of the varnish layer will be closed, thus significantly prolonging the durability of water-based varnishes and lacquers.



ELECTRONIC DOOR OPENING SYSTEM

SET 1

GRIP R6R9-515 150 cm
+ controller R6-BBX-CU + cable BBX-120-GU
+ power supply, cable grommet



SET 2

controller R6-BBX-CU + cable BBX-120-GU
+ power supply, cable grommet



SET 3

grip R6QE-515/R6QM-515/R6TM-515 150 cm
+ controller R6-BBX-CU + cable BBX-120-GU + power supply, cable grommet



INSERTS



EasyApp system

allows access to rooms without mechanical keys

DIGITAL VIEWER



DDS 2 MODEL

- up to 50 images can be recorded from the camera mounted in the viewer
- date and time of taking a photo
- possibility to add a card up to 8 GB
- built-in ringtones

DESIGN

EXTERNAL DOORS

You are welcome to create **your own model of an entrance door**. The technologies we use enable us to produce practically every design proposed by you.

The price of a door made according to an individual design is determined individually.

We look forward to seeing you!



P173

the crowns are only found on one side



STAINLESS STEEL GRIPS

colour INOX or powder painted black (extra charge for black railing)

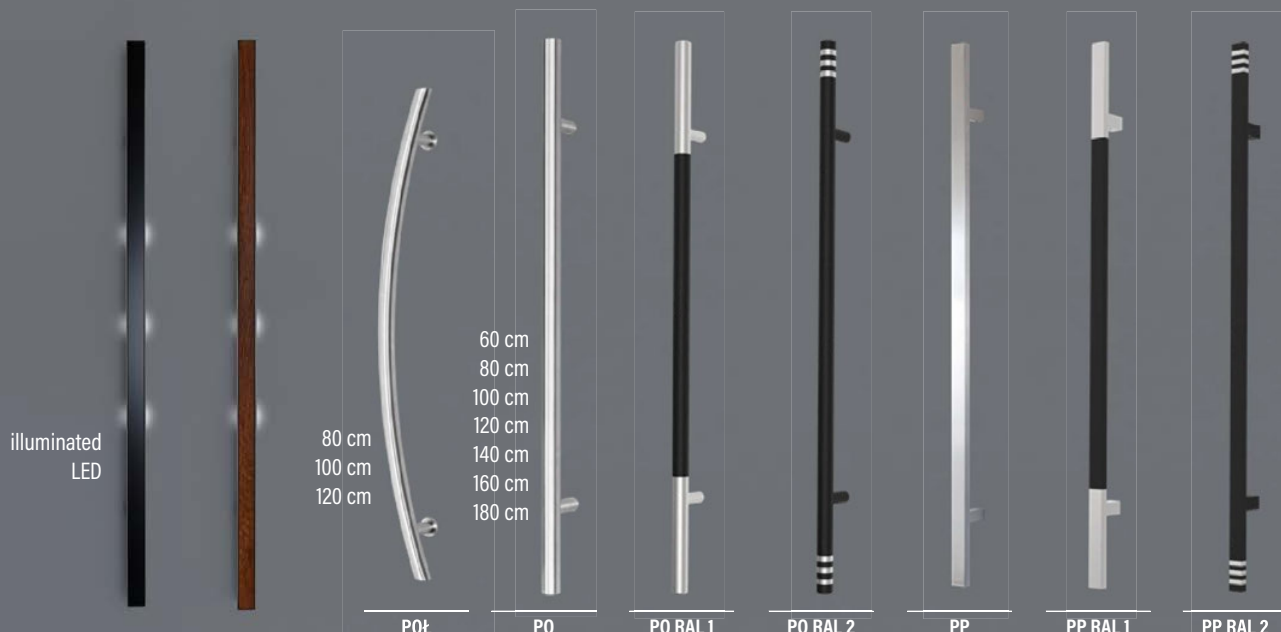

black glass with illumination
length 120, 150 or 180 cm

wood (old oak) with illumination
length 120, 150 or 180 cm

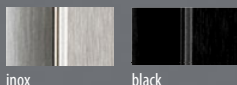

STAINLESS, INOX or BLACK HANDLES

PO - straight / slanting

60 cm
80 cm
100 cm
120 cm
140 cm
160 cm
180 cm

PP - straight / slanting

60 cm
80 cm
100 cm
120 cm
140 cm
160 cm
180 cm

SEMICIRCULAR - arched

80 cm
100 cm
120 cm
140 cm
160 cm
180 cm

DOOR OPENING

When choosing a door with a grip, you can choose from three ways of it opening:

- unlocking it with a key
- opening it with a "day-night" function on an electric strikes or with a key
- opening with a button or a key.

For an extra charge, the grips are available with a button "door opening function with an electric strike or a motor"



version 1

- push-button in the grip
- wireless contact
- electric strike
- power supply unit

version 2

- push-button in the grip
- motor for the GU lock
- wireless contact
- power supply unit

GRIP

made of 80x20 mm profile
colour black or inox

HANDLES AND FACEPLATES for single-sided grips



AXA SOLO
colour INOX or black



AXA SLIM WITH MOVABLE KNOB
colour INOX



AXA SLIM ESCUTCHEONS FOR DOUBLE HANDLES



HANDLES

AXA



AXA FAST
basic safety class in inox, nickel, brass and black colours



ODIN
safety class 3 in nickel, inox, patina colours



HAGA
basic safety class in nickel, inox, patina, black colours

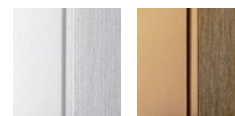

nickel

patina



inox

black

Metal-Bud



PRESTIGE
Safety class 3 in nickel, inox, patina, black colours



JUPITER FLEX
Safety class 3 in nickel, inox, patina, black colours



QUEBEC
Safety class 3 in nickel, patina, inox colours



TOTAL
inox, patina, black



METRO
stainless steel

RETRO HANDLES



HANDLE, FACEPLATE, RETRO KNOCKER:
in colours patina, inox glitter colours

SET WITH A RETRO GRIP:

- two brass grips
- decorative faceplates
- brass hinge caps patina, inox glossy, gold glossy

INSERTS



thickness 102 mm thick	thickness 82 mm thick	thickness 72 mm thick
insert, "B" class 65/60 universal	insert, "C" class 65/45 universal	65/35 lock knob B class
insert, „B" class 65/60 with a knob	insert, „C" class 65/45 with a knob	65/35 insert, universal, B class
insert, "C" class 65/60 universal	insert, "B" class 65/45 universal	inserts 65/35 Knob "C" class
insert, „C" class 65/60 with a knob	insert, „B" class 65/45 with a knob	inserts 65/35 Universal C Class
system inserts 1 key (2 pcs) „B" class 65/60	system inserts 1 key (2 pcs) „B" class 65/45	system inserts 1 key (2 pcs) „B" class 65/35
system inserts 1 key (2 pcs) "C" class 65/60	system inserts 1 key (2 pcs) "C" class 65/45	system inserts 1 key (2 pcs) „C" class 65/35



ERKADO

doors are our world



WOODEN DOORS P154

The warranty certificate and assembly manual are attached with products.
This catalogue serves as illustrative information material.
The manufacturer reserves the right to change the offered goods.
The actual colours in the colour charts may differ from those indicated in this Product Guide. Please check the colours in the original colour charts available at our dealerships.

Tests and certificates
- CE quality certificate for external doors

ERKADO DREWNO
Sp. z o. o. Sp. komandytowa

Chwałowice 156
37-455 Radomyśl n/Sanem
Poland

Phone +48 15 845 33 88
NIP 8652562260
www.erkado.pl

e-mail: dz@erkado.pl
www.erkado.pl

Scan your code and download
this Product Guide



www.erkado.pl