



TECHNICAL DATA

Garage doors

CONTENT

4 TRACKS

- 5.....R30
- 6.....R40 - SM
- 7.....R40 - UM
- 8.....R40 - TM
- 9.....TL LHR - FM
- 10.....TL LHR - RM
- 11.....TL STD
- 12.....Additional options to reduce required headroom and increase daylight opening
- 13.....TL LHR - FM PR
- 14.....TL LHR - RM PR
- 15.....TL STD PR
- 16.....Door size, pitch angle and required headroom correlation
- 17.....SSD

18 PANELS

- 19.....PANEL TYPES
- 25.....ALU-framed PANEL TYPES
- 26.....RETRO

27 DECOR APPLIQUÉS

- 28.....STAINLESS METAL APPLIQUÉS OPTIONS

29 PVC WINDOWS / STAINLESS STEEL WINDOWS

- 30.....PVC WINDOWS Scratch-proof double glazing
- 31.....Stainless steel windows

32 WICKET DOOR

- 33.....Wicket door critical dimensions
- 34.....Standard threshold / Low threshold
- 35.....External view
- 36.....CASSETTE panels

37 SIDE-HINGED DOORS

- 38.....SIDE DOOR (SH1)
- 41.....DOUBLE HINGED DOOR (SH2)

TRACKS



R30

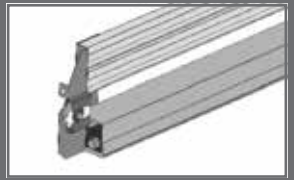

h (headroom)	110 mm (manual) 150 mm (with el. operator)
SL / SR (sideroom)	80 mm
Daylight opening	H - 30 mm

H	D
≤ 2070	2680
2071 - 2125	2880

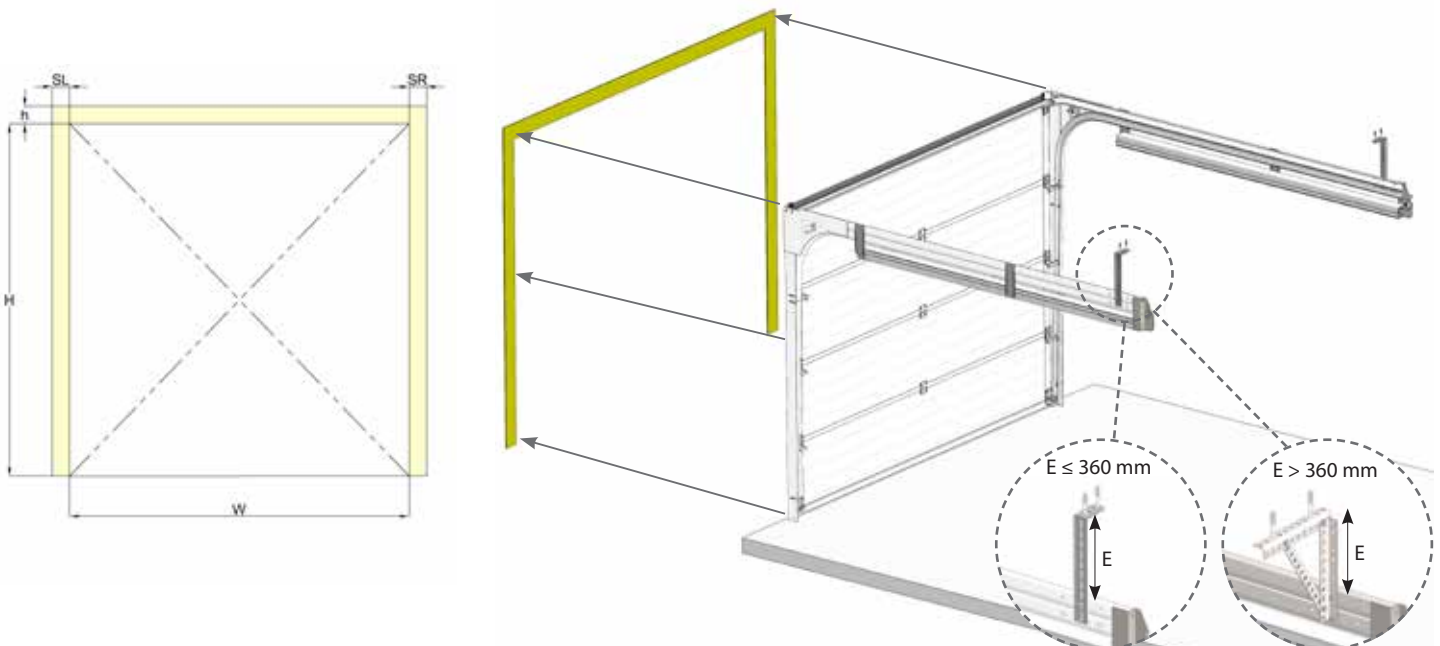
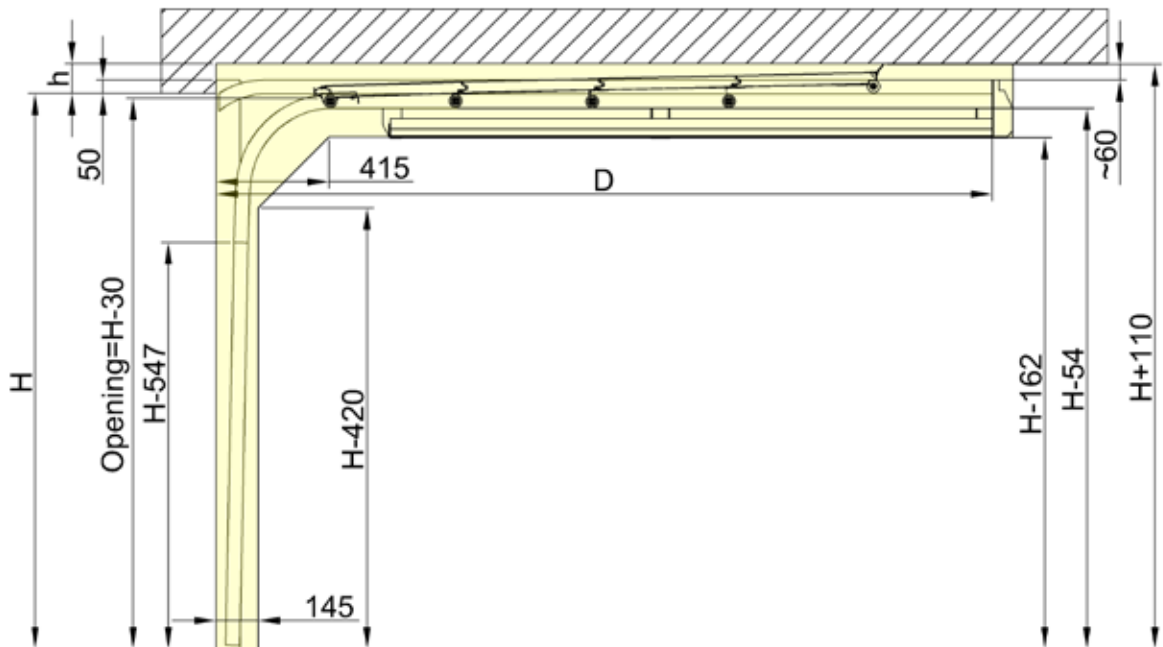
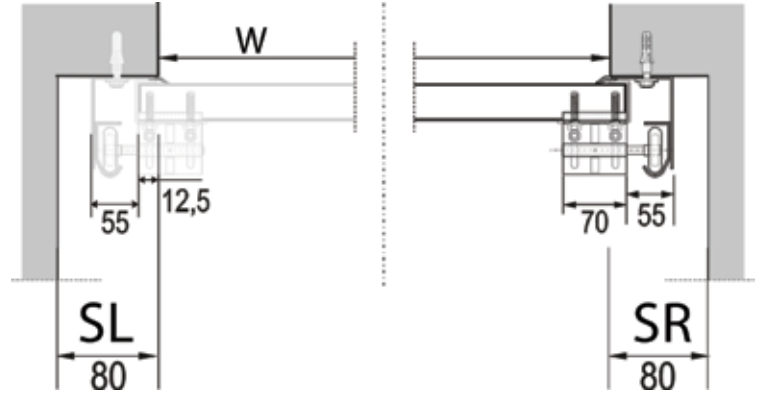

R40 - SM

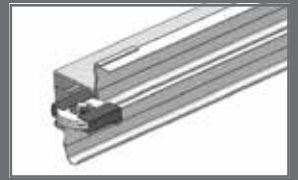

h (headroom)	110 mm (manual) 150 mm (with el. operator)
SL / SR (sideroom)	150 mm
Daylight opening	H - 30 mm

See page 12 for options to reduce required headroom and increase daylight opening.

H	D
≤ 2070	2720
2071 - 2270	2920
2271 - 2400	3047
2401 - 2500	3300

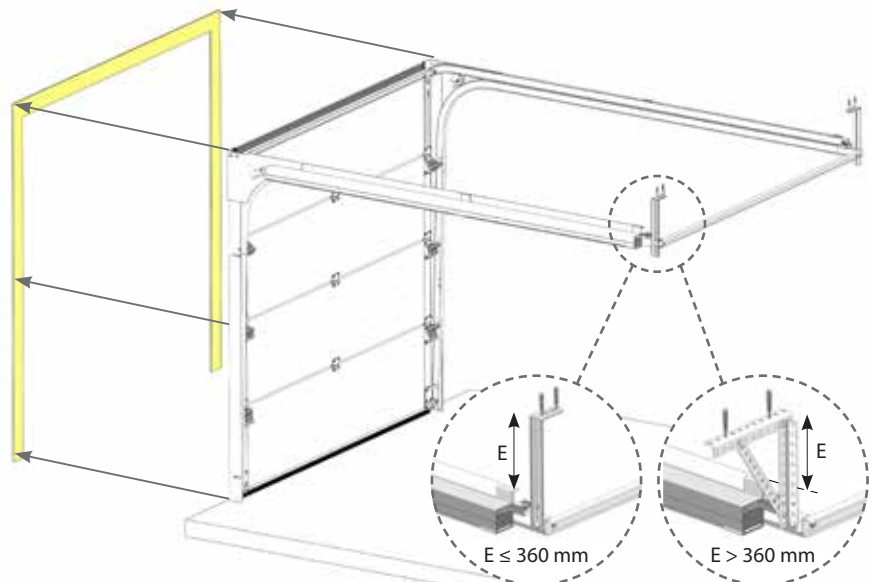
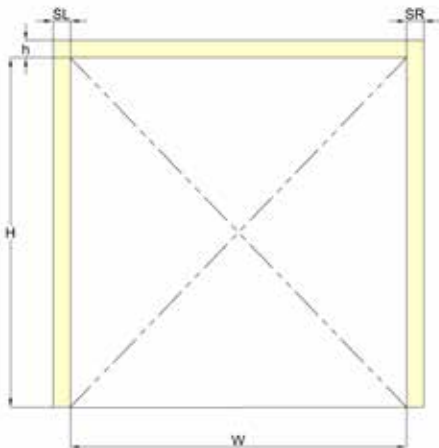
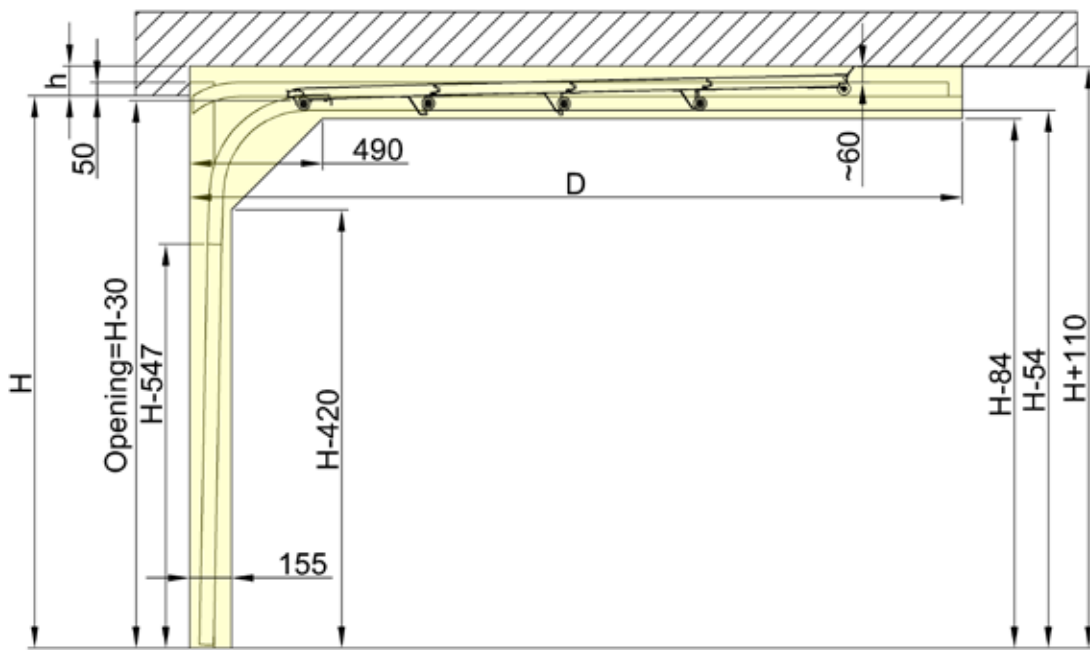
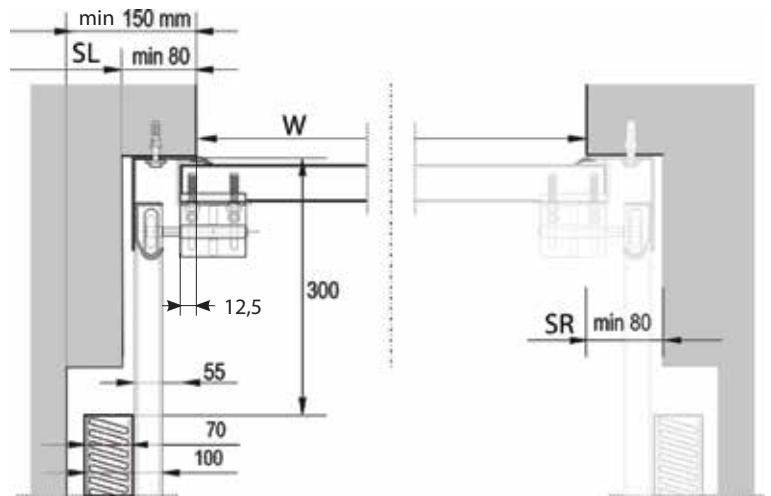

R40 - UM

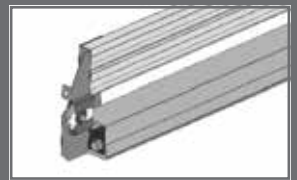

h (headroom)	110 mm (manual) 150 mm (with el. operator)
SL / SR (sideroom)	80 mm
Daylight opening	H - 30 mm

See page 12 for options to reduce required headroom and increase daylight opening.

H	D
≤ 2070	2680
2071 - 2270	2880
2271 - 2400	3007
2401 - 2500	3260

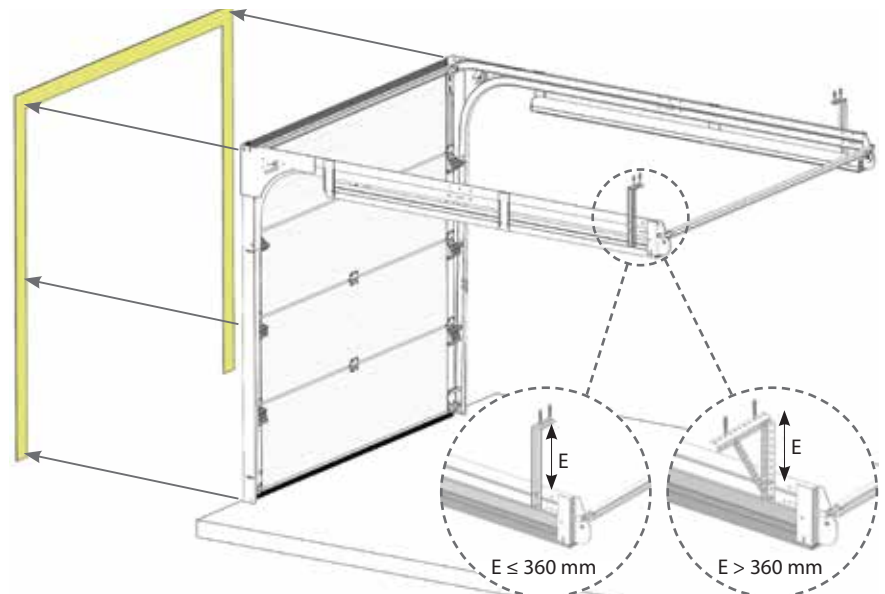
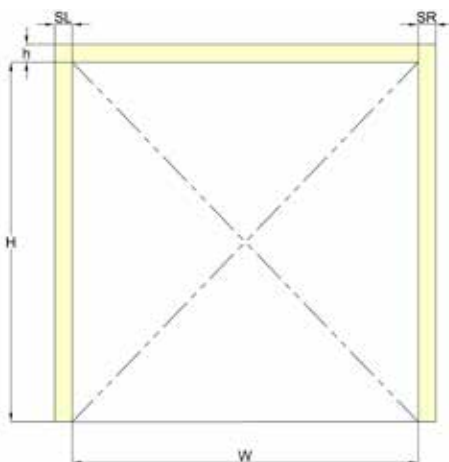
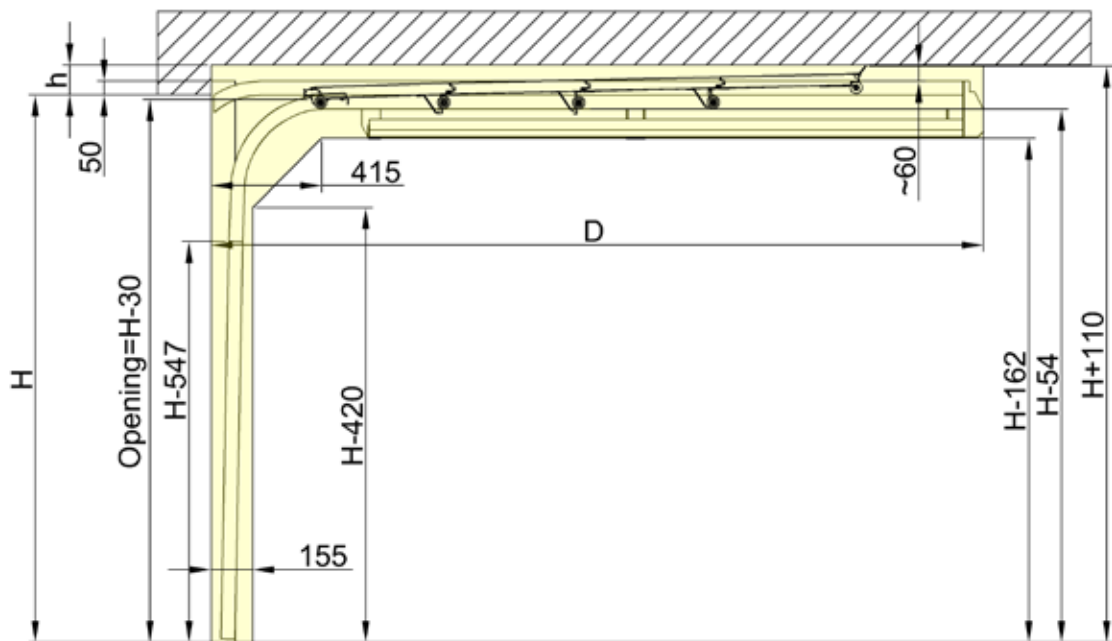
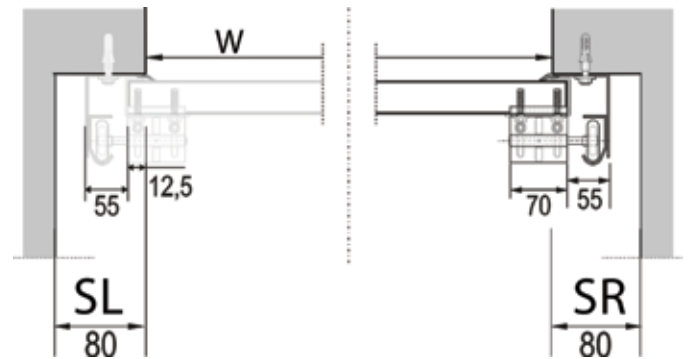

R40 - TM



h (headroom)	180 mm (with el. operator or manual)
SL / SR (sideroom)	80 mm
Daylight opening	H - 30 mm

H	D
≤ 2125	2880
2126 - 2250	3007
2251 - 2500	3260

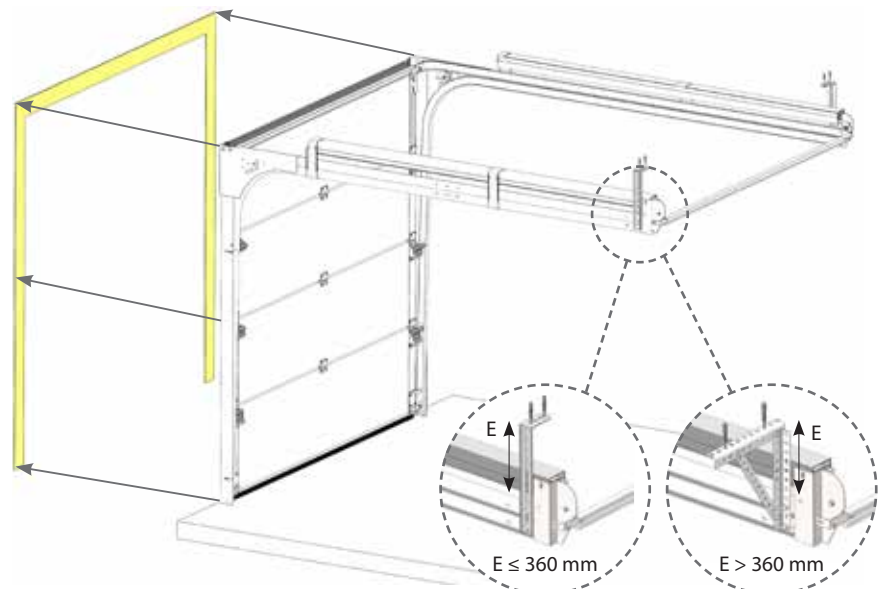
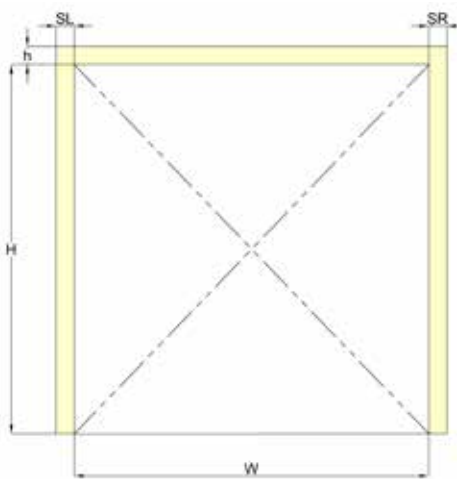
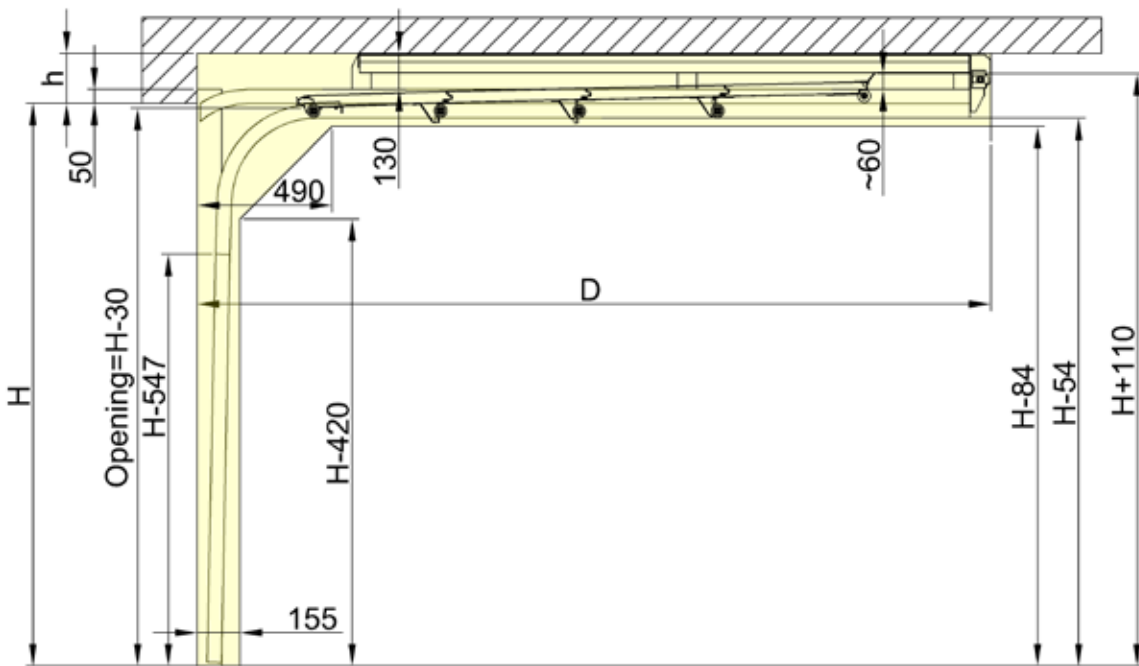
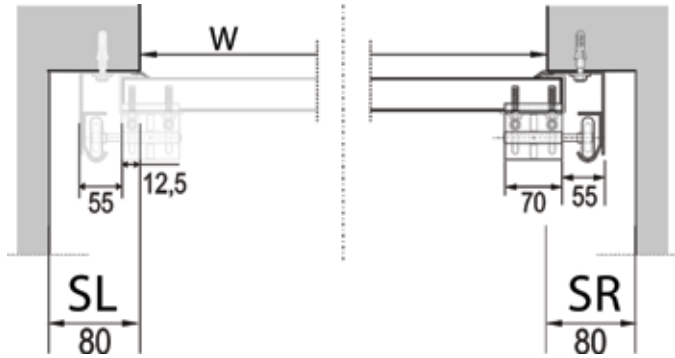

TL LHR - FM

h (headroom)	180 mm (with el. operator and manual)
SL / SR (sideroom)	100 mm
Daylight opening	H - 130 mm (manual) H - 10 mm (with el. operator) H - 50, W ≥ 4500 (with el. operator)
D (fitting depth)	H + 550 mm

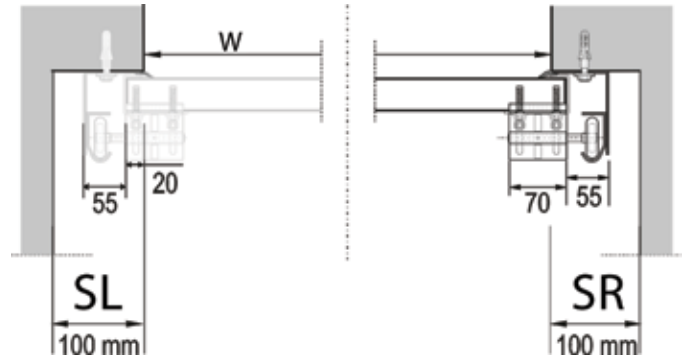

Number of required suspensions	
W ≤ 3000	1 suspension per side
W > 3000	2 suspensions per side

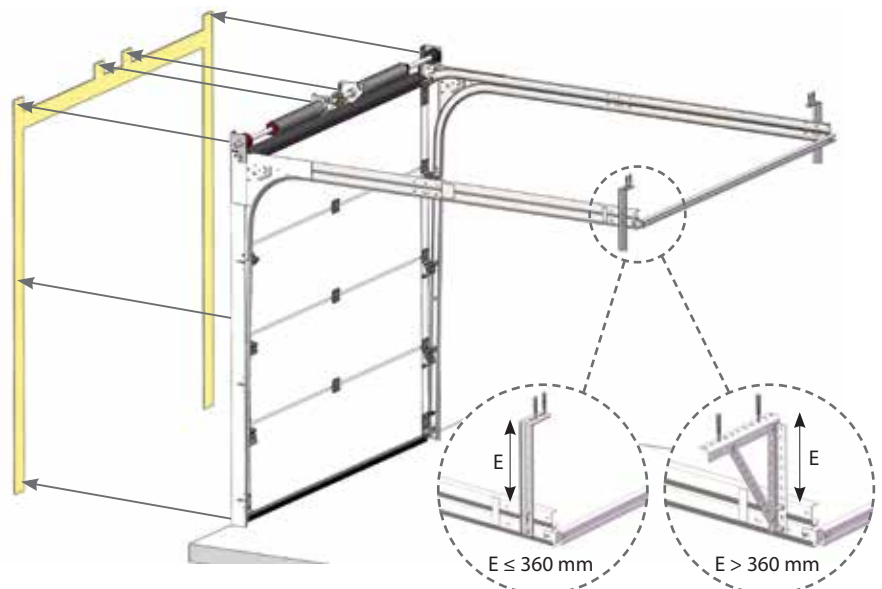
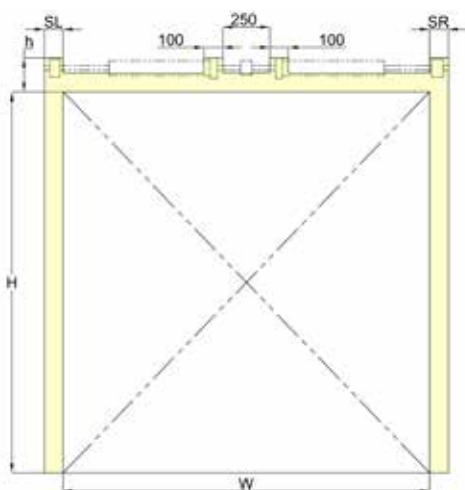
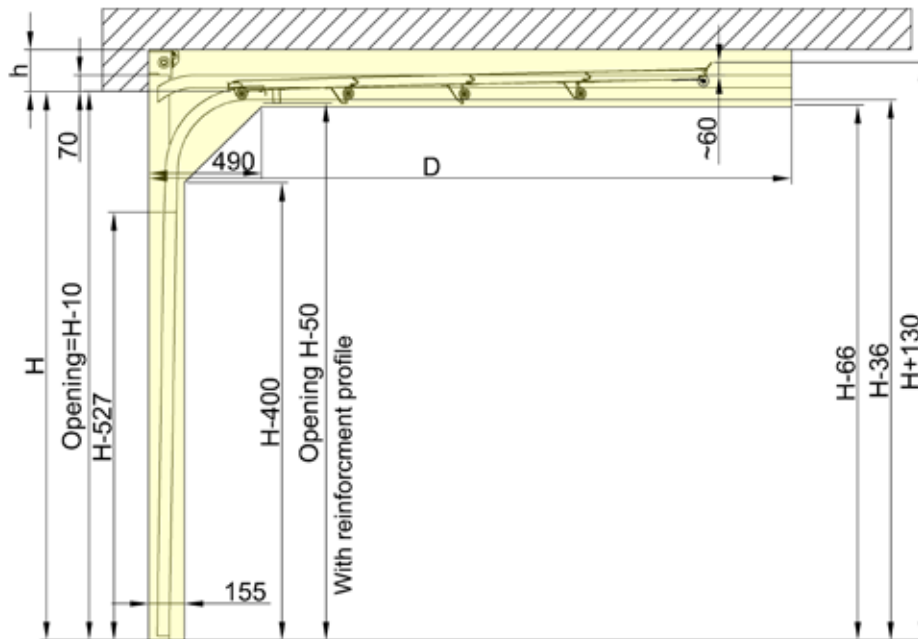

W > 5000 mm regarding the quantity of springs consult the manufacturer

TL LHR - RM

h (headroom)	120 mm (manual) 160 mm (with el. operator)
SL / SR (sideroom)	100 mm
Daylight opening	H - 160 mm (manual) H - 20 mm (with el. operator) H - 60, W ≥ 4500 (with el. operator)
D (fitting depth)	H + 700 mm H + 1100 mm with Sommer operator

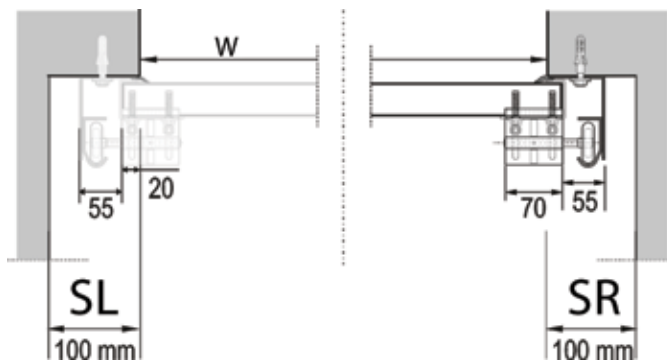

Number of required suspensions	
W ≤ 3000	1 suspension per side
W > 3000	2 suspensions per side

See page 12 for options to reduce required headroom and increase daylight opening.

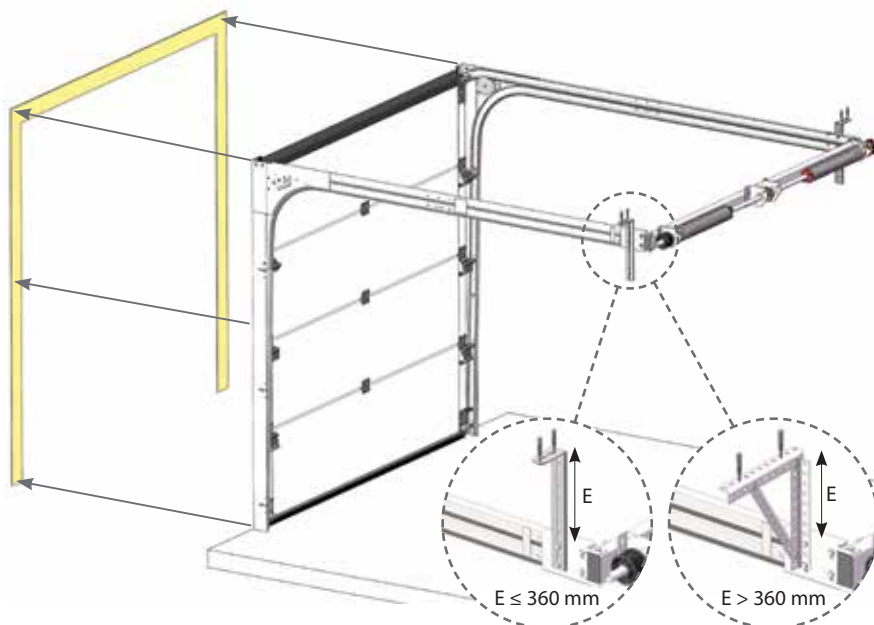
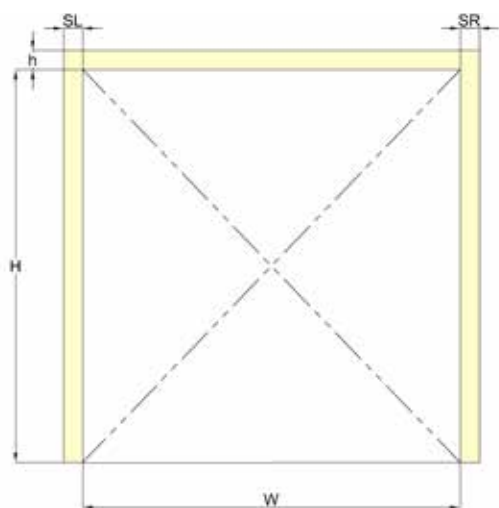
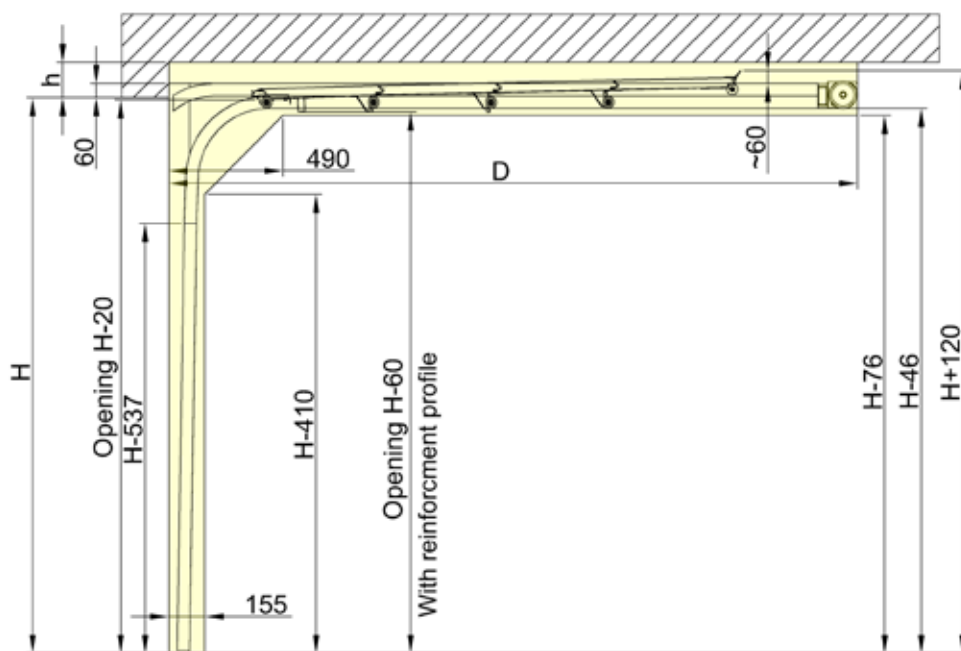

TL STD

h (headroom)	340 mm (manual) 370 mm (with el. operator)
SL / SR (sideroom)	100 mm
Daylight opening	H
D (fitting depth)	H + 510 mm

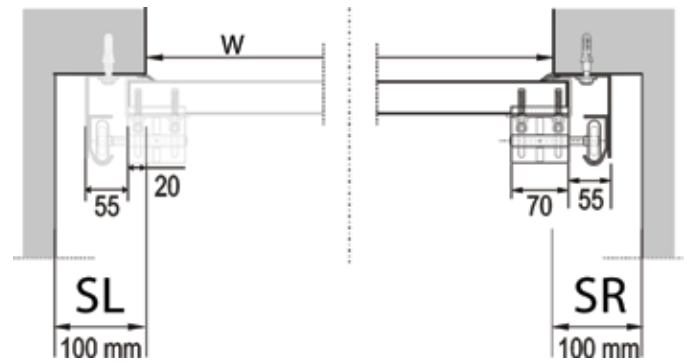

Number of required suspensions	
W ≤ 3000	1 suspension per side
W > 3000	2 suspensions per side

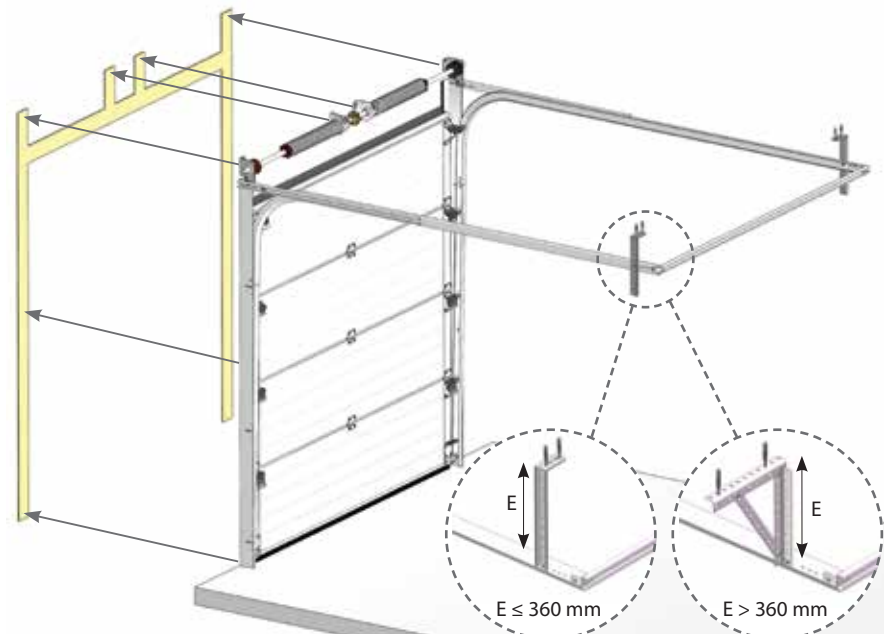
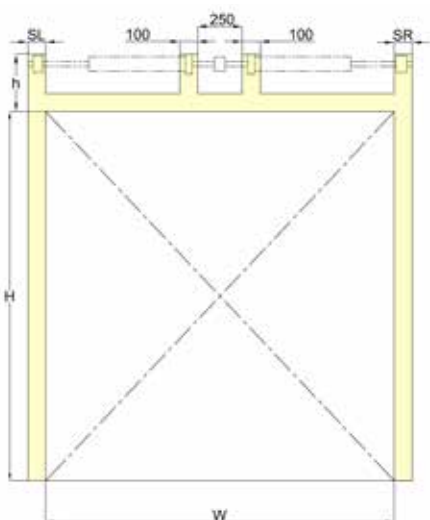
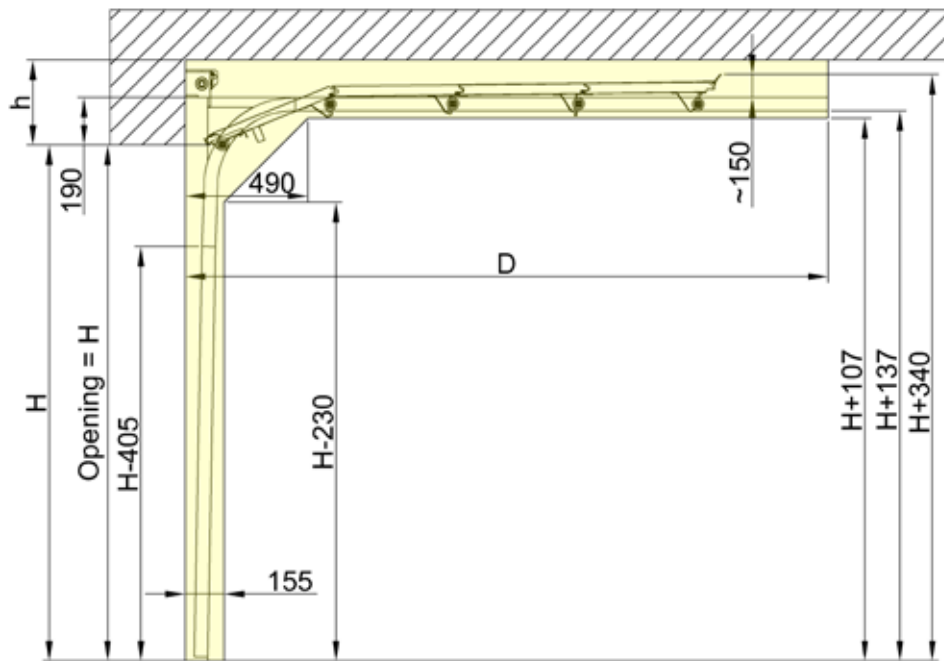

W > 5000 mm regarding the quantity of springs consult the manufacturer

Additional options to reduce required headroom and increase daylight opening

Min headroom (mm)								
Equipment	Model							
	R40 SM		R40 UM		R40 TM		LHR-RM	
	Manual	Operator	Manual	Operator	Manual	Operator	Manual	Operator
Standart top brackets and top weather seal on panel	110	150	110	150	180	180	120	160
Standart top brackets and top weather seal on lintel	90	130	90	130	180	180	90	130
Top weather seal on lintel + LHR top brackets (18023) + with side brackets (18010)	70	110	not available	not available	180	180	80	120
Universal lock 22008	95		95		180		105	
Knob lock 22009	100		100		180		110	
With pass door	not available		not available		not available		105	

Max daylight opening (mm)							
Model							
R40 SM		R40 UM		R40 TM		LHR-RM	
Manual	Operator	Manual	Operator	Manual	Operator	Manual	Operator
H-120	H-30	H-120	H-30	H-120	H-30	H-160	H-20 (W ≤ 4500) H-40 (W > 4500)

For full daylight opening use extended vertical tracks +30 mm (R40 UM/SM/TM), +20 mm LHR-RM (W≤4500)
You need more headroom (+30 mm or +20 mm) then required min headroom

Fitting depth (mm)				
Opening H, mm	Model			
	R40 SM	R40 UM	R40 TM	LHR-RM
≤ 2070	2720	2680	2680	H+700
2071-2270	2920	2880	2880	H+700
2271-2400	3047	3007	3007	H+700
2401-2500	3300	3260	3260	H+700

Min sideroom (mm)			
Model			
R40 SM	R40 UM	R40 TM	LHR-RM
150	80	80	100

TL LHR - FM PR

h (headroom)	Go to page 16
SL / SR (sideroom)	100 mm
Daylight opening	H - 130 mm (manual) H - 10 mm (with el. operator) H - 50, W \geq 4500 (with el. operator)
D (fitting depth)	H + 550 mm

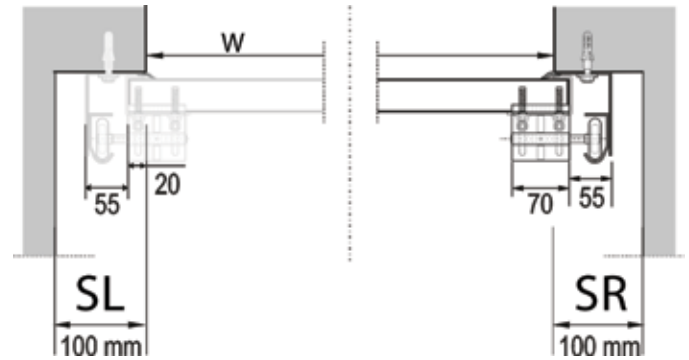

Number of required suspensions	
W \leq 3000	1 suspension per side
W > 3000	2 suspensions per side

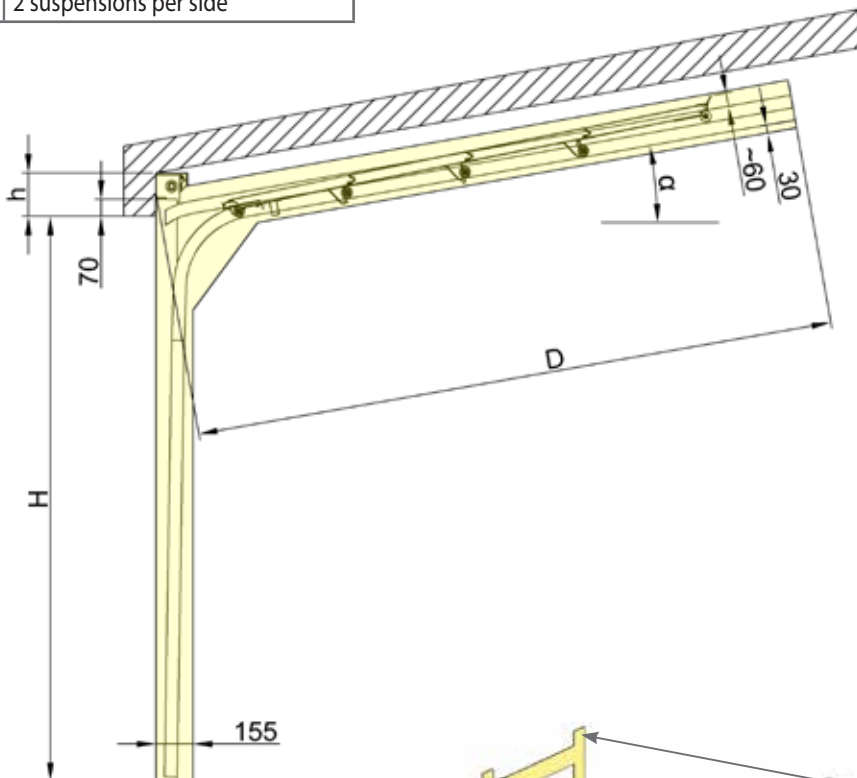

Regarding quantity of springs
consult manufacturer

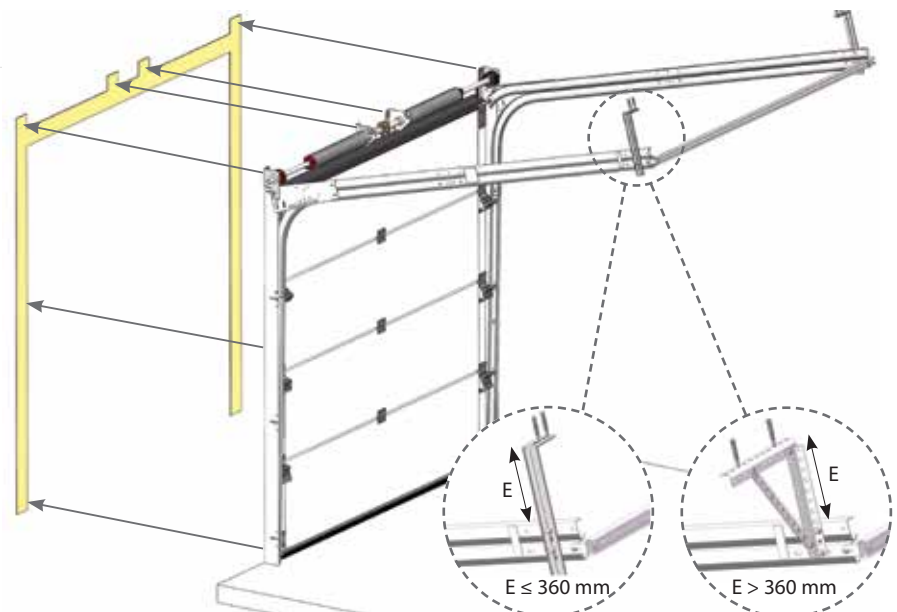

TL LHR - RM PR

h (headroom)	120 mm (manual) $\alpha \leq 15^\circ$ 160 mm (with el. operator) $\alpha \leq 15^\circ$ *for bigger angle consult manufacturer
SL / SR (sideroom)	100 mm
Daylight opening	H - 160 mm (manual) H - 20 mm (with el. operator) H - 60, W \geq 4500 (with el. operator)
D (fitting depth)	H + 700 mm H + 1100 mm (with sommer operator)

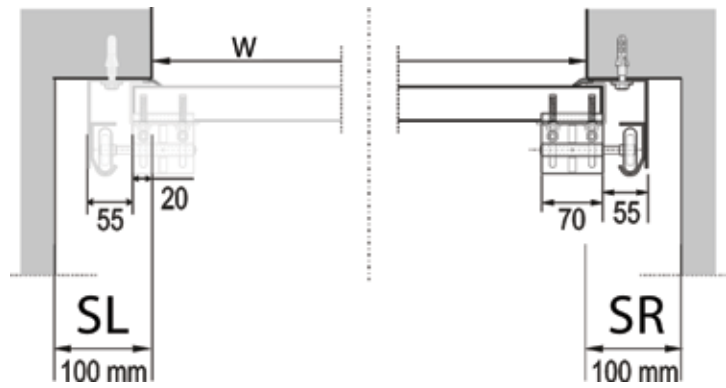

Number of required suspensions	
W \leq 3000	1 suspension per side
W $>$ 3000	2 suspensions per side

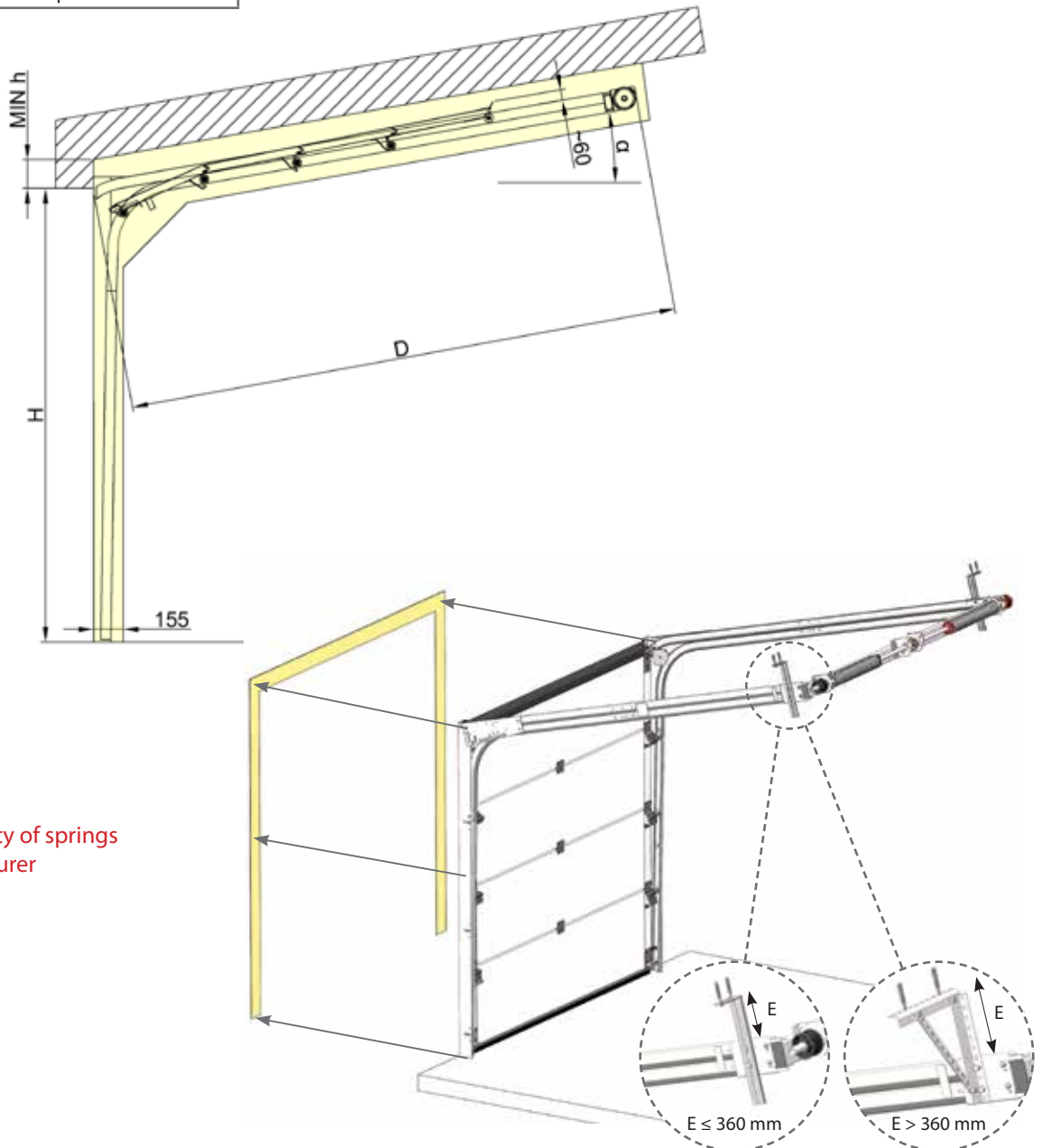

Regarding quantity of springs
consult manufacturer

TL STD PR

h (headroom)	Go to page 16
SL / SR (sideroom)	100 mm
Daylight opening	H
D (fitting depth)	H + 510 mm

Number of required suspensions	
W ≤ 3000	1 suspension per side
W > 3000	2 suspensions per side

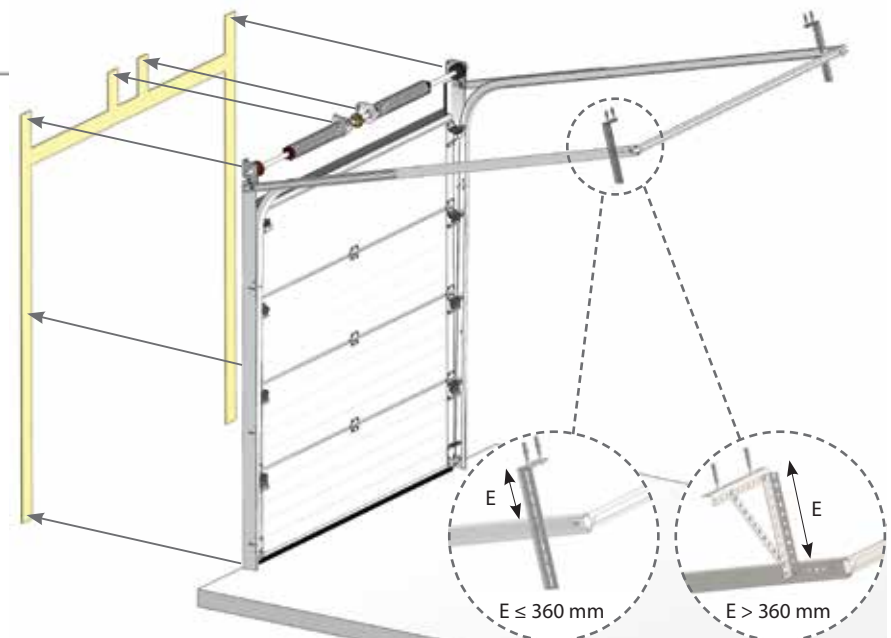
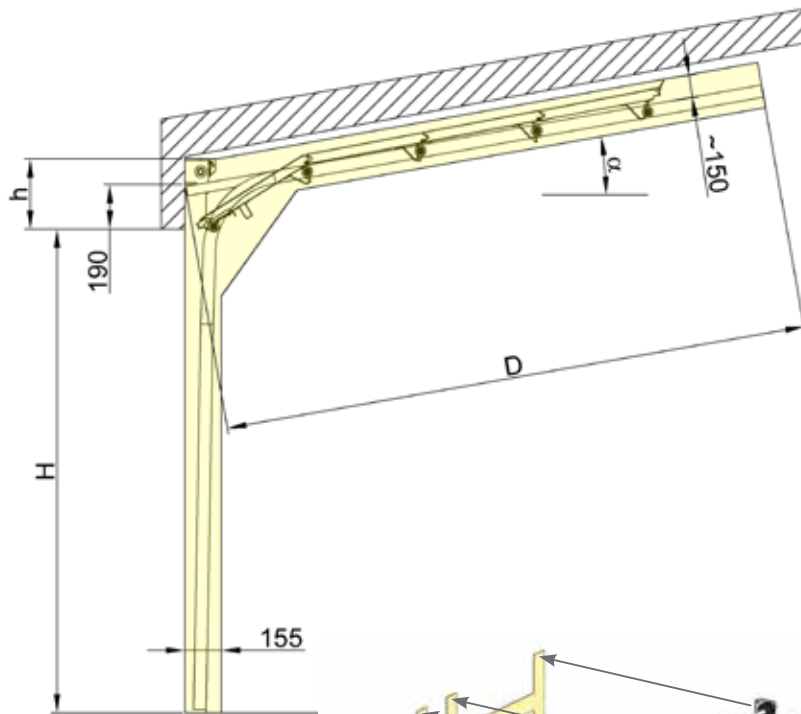
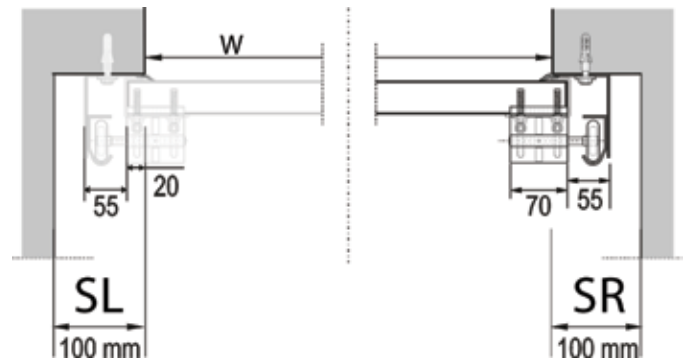

Regarding quantity of springs
consult manufacturer

Door size, pitch angle and required headroom correlation



All sizes are for doors without operator

Required headroom for doors with woodgrain / stucco panels

	$\alpha \leq 10^\circ$		$10^\circ < \alpha \leq 15^\circ$		$15^\circ < \alpha \leq 20^\circ$		$20^\circ < \alpha \leq 25^\circ$		$25^\circ < \alpha \leq 30^\circ$	
	STD	LHR-FM	STD	LHR-FM	STD	LHR-FM	STD	LHR-FM	STD	LHR-FM
H ≤ 2000	340	180	340	180	340	180	340	180	370	270
H ≤ 2250	340	180	340	180	340	180	370	270	370	270
H ≤ 2500	340	180	340	180	370	270	370	270	370	270
H ≤ 2750	340	180	370	270	370	270	370	270	370	270
H ≤ 3000	370	270	370	270	370	270	370	270	430	310

Required headroom for doors with woodgrain / stucco panels and wicket door

	$\alpha \leq 10^\circ$		$10^\circ < \alpha \leq 15^\circ$		$15^\circ < \alpha \leq 20^\circ$		$20^\circ < \alpha \leq 25^\circ$		$25^\circ < \alpha \leq 30^\circ$	
	STD	LHR-FM	STD	LHR-FM	STD	LHR-FM	STD	LHR-FM	STD	LHR-FM
H ≤ 2000	340	180	340	180	340	180	370	270	370	270
H ≤ 2250	340	180	340	180	340	180	370	270	370	270
H ≤ 2500	340	180	340	180	370	270	370	270	370	270
H ≤ 2750	340	180	370	270	370	270	370	270	370	270
H ≤ 3000	370	270	370	270	370	270	370	270	430	310

Required headroom for doors with smooth (SLICK type) panels

	$\alpha \leq 10^\circ$		$10^\circ < \alpha \leq 15^\circ$		$15^\circ < \alpha \leq 20^\circ$		$20^\circ < \alpha \leq 25^\circ$		$25^\circ < \alpha \leq 30^\circ$	
	STD	LHR-FM	STD	LHR-FM	STD	LHR-FM	STD	LHR-FM	STD	LHR-FM
H ≤ 2000	340	180	340	180	340	180	370	270	370	270
H ≤ 2250	340	180	340	180	370	270	370	270	370	270
H ≤ 2500	340	180	370	270	370	270	370	270	370	270
H ≤ 2750	370	270	370	270	370	270	370	270	370	270
H ≤ 3000	370	270	370	270	370	270	370	270	430	310

Required headroom for doors with smooth (SLICK type) panels and wicket door

	$\alpha \leq 10^\circ$		$10^\circ < \alpha \leq 15^\circ$		$15^\circ < \alpha \leq 20^\circ$		$20^\circ < \alpha \leq 25^\circ$		$25^\circ < \alpha \leq 30^\circ$	
	STD	LHR-FM	STD	LHR-FM	STD	LHR-FM	STD	LHR-FM	STD	LHR-FM
H ≤ 2000	340	180	340	180	340	180	370	270	370	270
H ≤ 2250	340	180	340	180	370	270	370	270	370	270
H ≤ 2500	340	180	370	270	370	270	370	270	370	270
H ≤ 2750	370	270	370	270	370	270	370	270	370	270
H ≤ 3000	370	270	370	270	370	270	435	310	430	310

SSD

STANDARD SIDEROOM

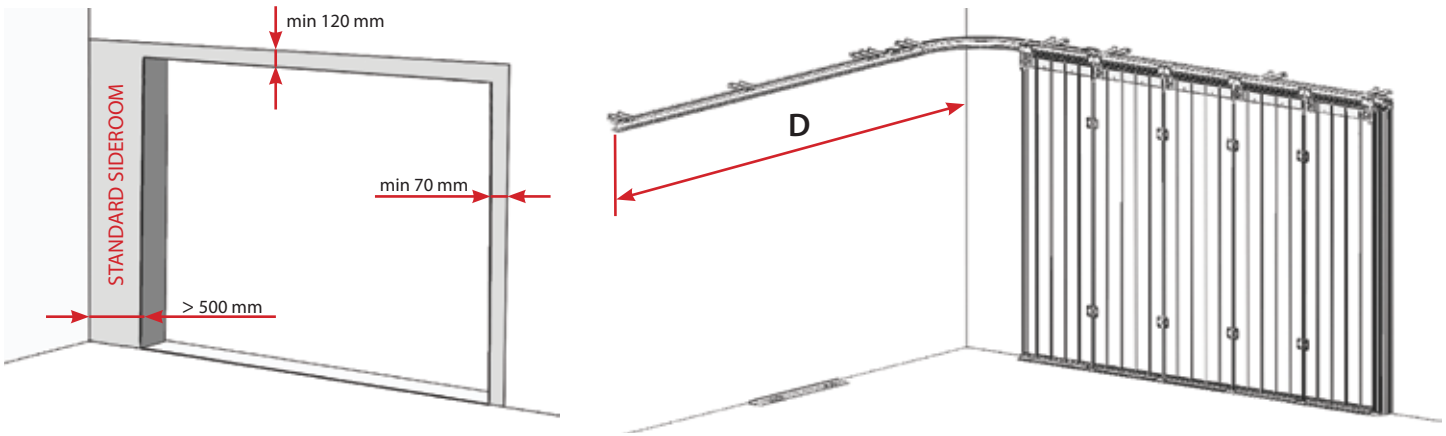

SMALL SIDEROOM

SIDEROOM*	RADIUS	ARM	D	Operator fitting place***
150 - 200	R520	R520 + ARM L = 1000	W + 1250	side wall only
201 - 300	R520	R520 + ARM L = 600	W + 800	side wall
301 - 500	R520	R520 + ARM L = 400	W + 600	side wall
> 500	R420	-	W + 100	lintel

* min sideroom on opening side (for manual operator min 200 mm required).

*** Operator movement range must be longer than W, if standard rail is too short use additional rail extensions.

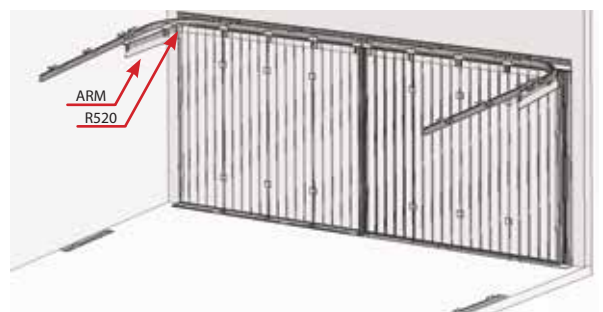
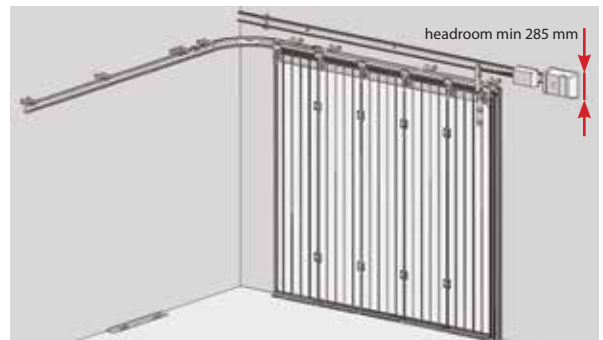
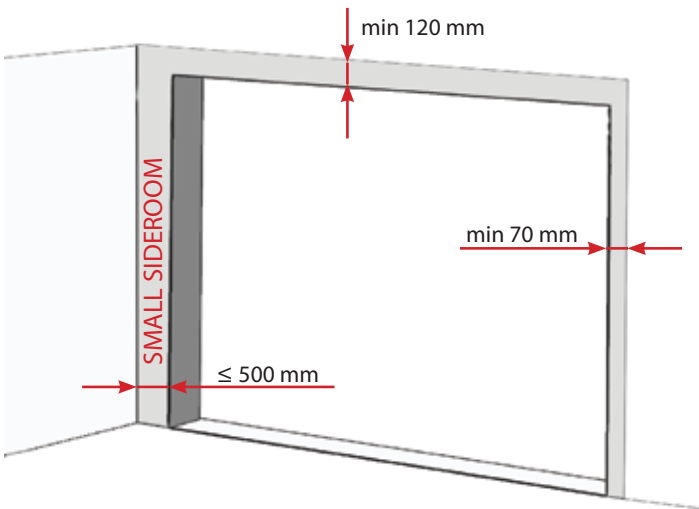

SINGLE DOOR

H = max 3000 mm, W = max 6000 mm

ANGLE RANGES

$\alpha = \text{min } 85^\circ, \text{ max } 180^\circ$

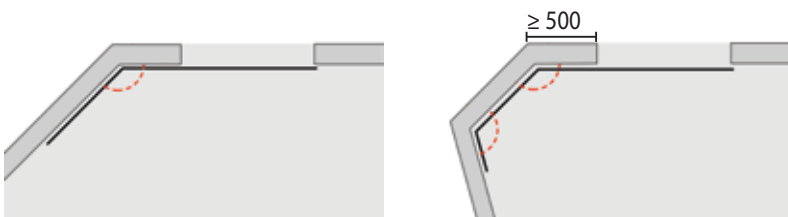

PANELS



PANEL TYPES

Panel type	S (mm)	K		Δ	Panel weight		Tolerances			U value
		Kcal m ² hK	Watt m ² K	Kcal mK	Kg/m	Kg/m ²	Thickness	Width	Length	W m ² K
R-500	40	0,43	0,50	0,017	5,6	11,2	+/- 2	+/- 1	+/- 5	0,52
R-610					6,8	11,2				

Section type	U value (W/m ² K)	Wind class	Water penetration class	Air permeability class
Sandwich	1 - 1,6	5	3	2

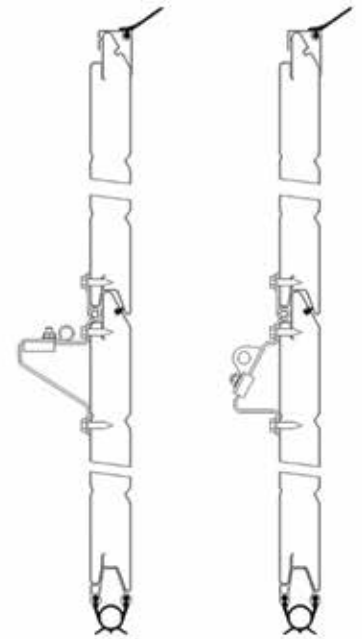
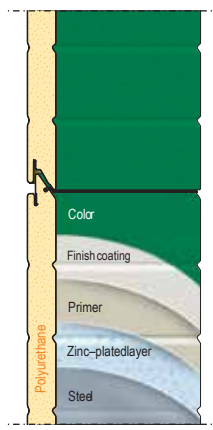

All panels Internal side - ribbed, stucco embossed RAL 9002

W > 4500

W ≤ 4500

RIB

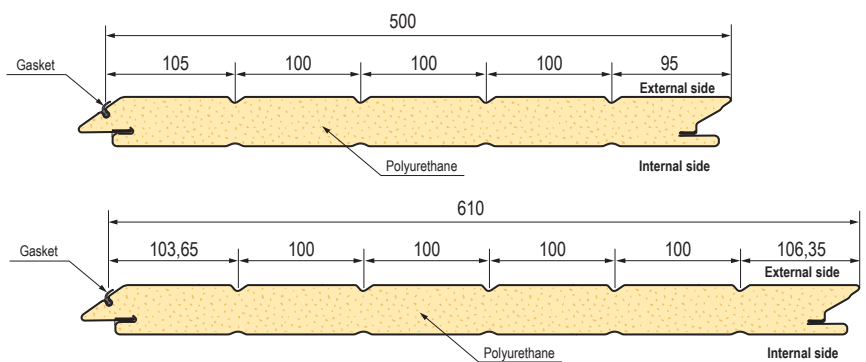
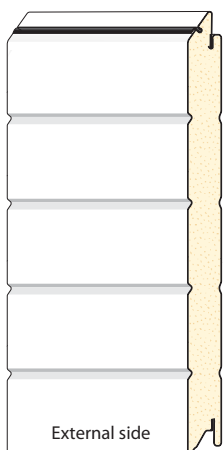

PANEL SURFACES

PANEL COLOURS

STANDARD COLOURS

woodgrain

stucco

painting RAL

RAL 9016,
RAL 8017.

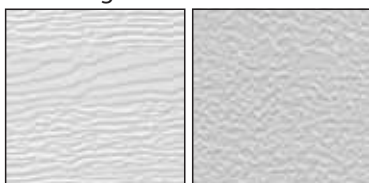

PANEL TYPES

MIDRIB

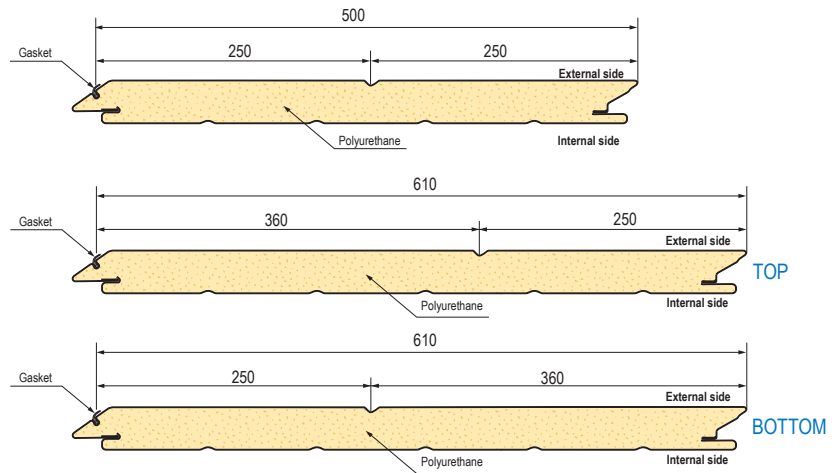
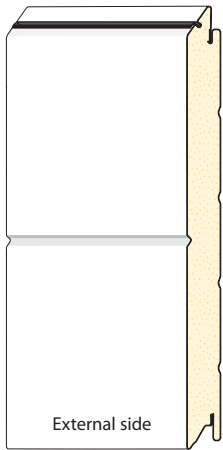

PANEL SURFACES

woodgrain



stucco



smooth



PANEL COLOURS

Painted RAL



RAL PEARL
(only smooth surface)



STANDARD COLOURS

RAL 9016 (stucco, woodgrain),
RAL 8017 (woodgrain),
RAL 6009 (woodgrain),
RAL 7016 (woodgrain),
GOLDEN OAK (smooth),
OLD OAK (smooth),
LIGHT OAK (smooth),
MAHOGANY (smooth),
DARK OAK (smooth).

TOPRIB

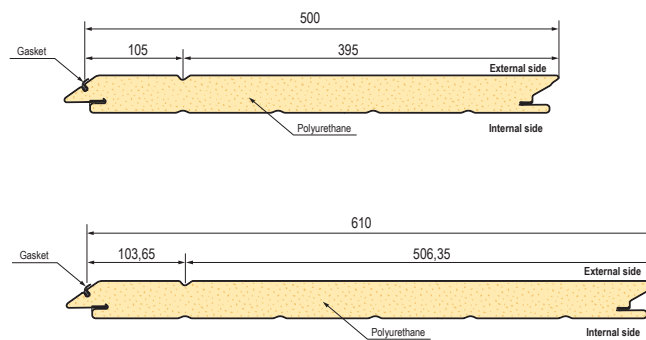
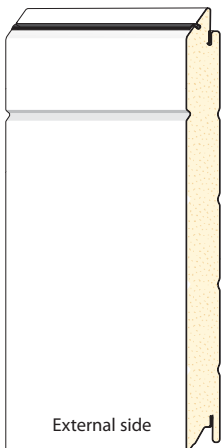

PANEL SURFACES

smooth



PANEL COLOURS

Painted RAL



RAL PEARL



STANDARD COLOURS

RAL 9016,
RAL 7016.

PANEL TYPES

MICRORIB

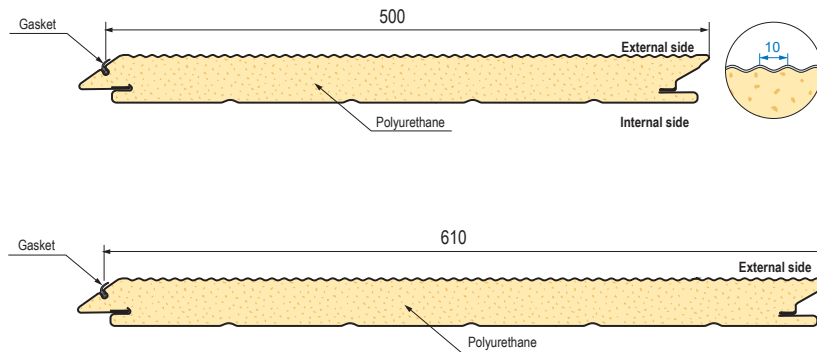
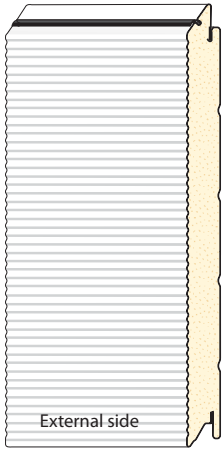

PANEL SURFACES

PANEL COLOURS

STANDARD COLOURS

smooth



painting RAL



RAL PEARL (single sided)



RAL 9016

MACRORIB

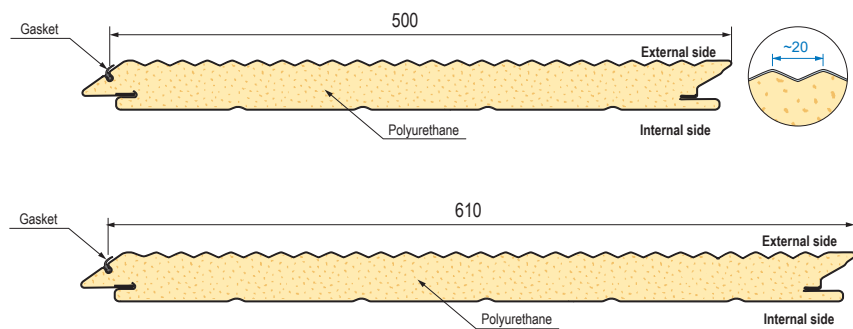
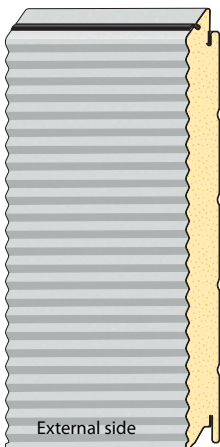

PANEL SURFACES

PANEL COLOURS

STANDARD COLOURS

stucco



painting RAL



RAL 9007,
RAL 9016,
RAL 7016.

Standard colour: RAL9007.

PANEL TYPES

FLUSH

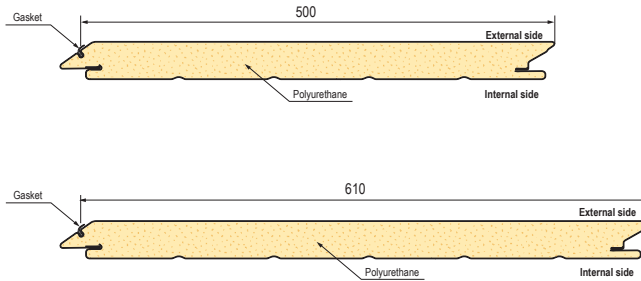
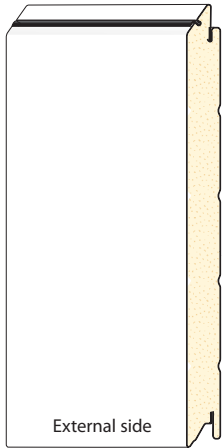

PANEL SURFACES

PANEL COLOURS

STANDARD COLOURS

woodgrain

stucco

painting RAL

RAL 9016.

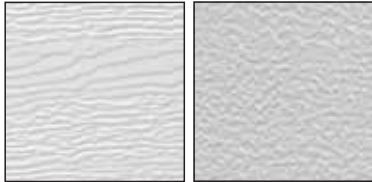

SLICK

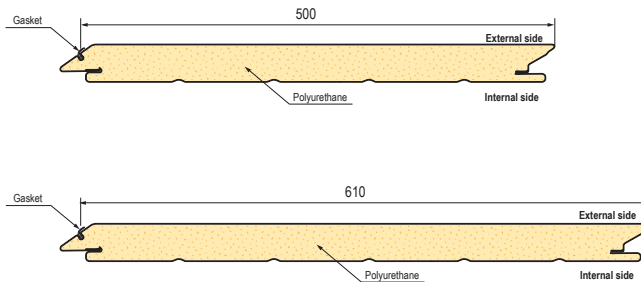
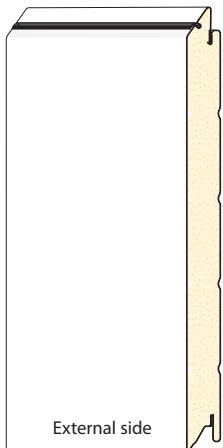

PANEL SURFACES

PANEL COLOURS

STANDARD COLOURS

smooth

painting RAL

RAL PEARL

RAL 9016,
RAL 9006,
RAL 7016,
RAL 9004.



SLICK PLUS

STANDARD COLOURS

Stainless Steel, Copper, Metallic Anthracite, 3D Grey (similar RAL7016), 3D White (similar RAL9016), Linea (similar RAL7016).

PANEL TYPES

CASSETTE

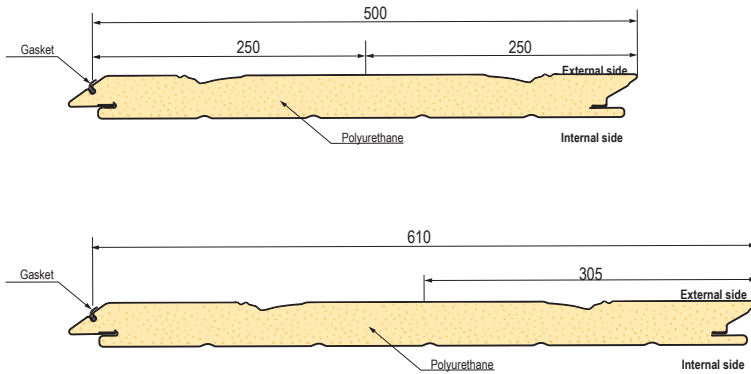
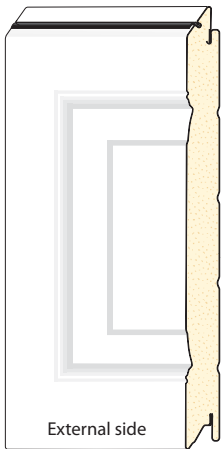

WOOD
IMAGES



Golden Oak

PANEL
SURFACES

PANEL
COLOURS

STANDARD
COLOURS

woodgrain

painting RAL

RAL 9016,
GOLDEN OAK (woodgrain).

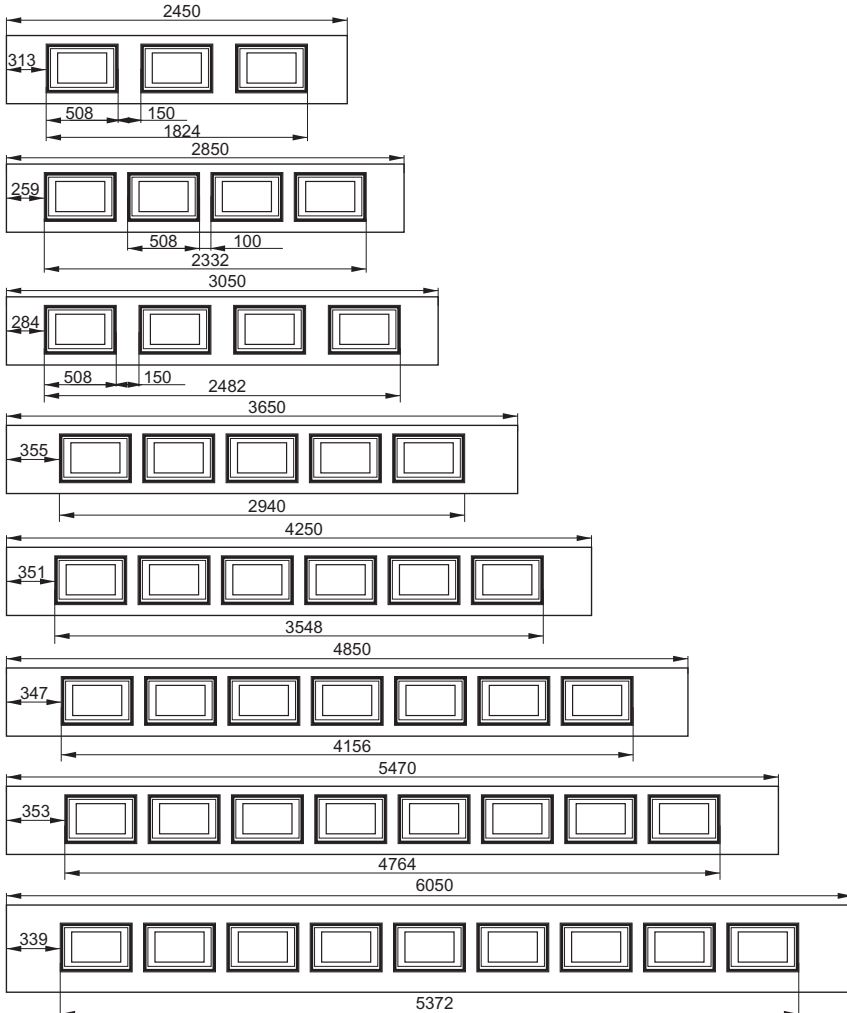
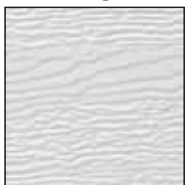

Reinforcement profiles on sandwich panels

Opening width, W	Profile type	Example No.	Main location on panel	Quantity of reinforcements
$W \leq 4500$	-	-	-	-
$4500 < W \leq 5000$	Bottom reinforced + omega	1-A	Top of panel (for omega)	1 + 1 = 2
	Omega	1-B		
$5000 < W \leq 5500$	Omega	2	Top partion of panel	on every second doorpanel
$5500 < W \leq 6000$	Omega	3	Top of panel	on every second doorpanel + 1 on top

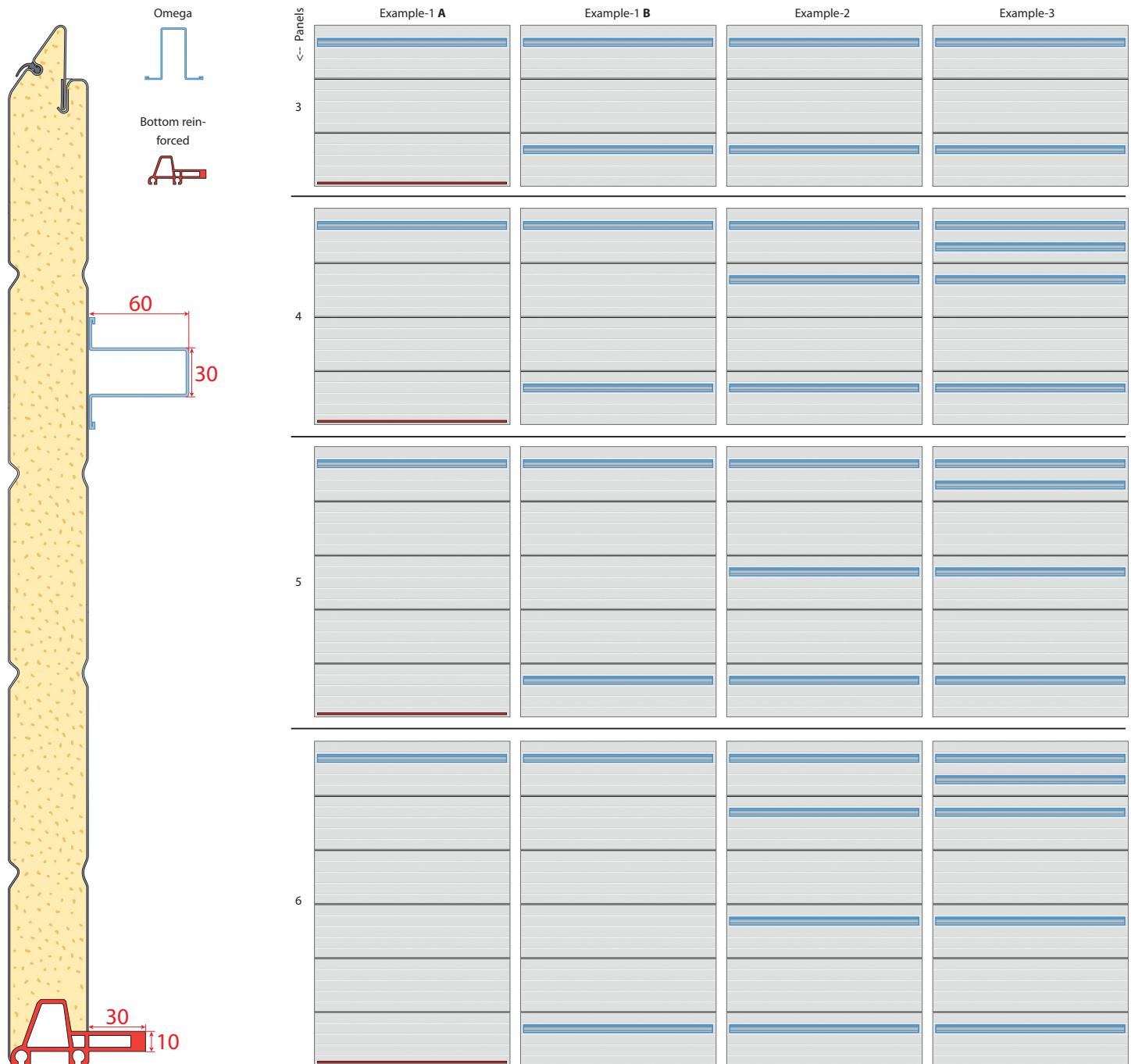

Profile fixing points



ALU-framed PANEL TYPES

Double insulated Acrylic (Clear / Matt / "Frosted") glazing

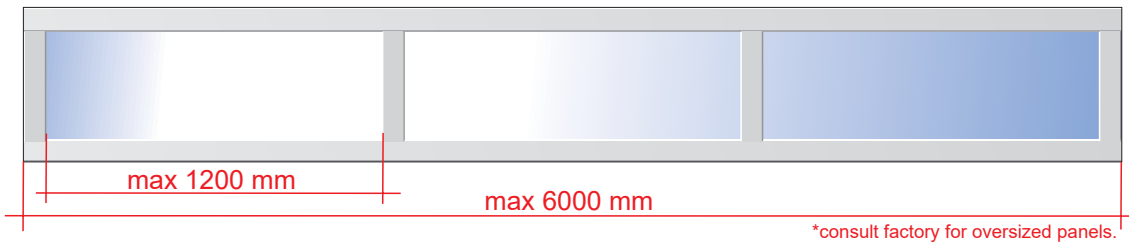

Single / Double glazing (safety glass)

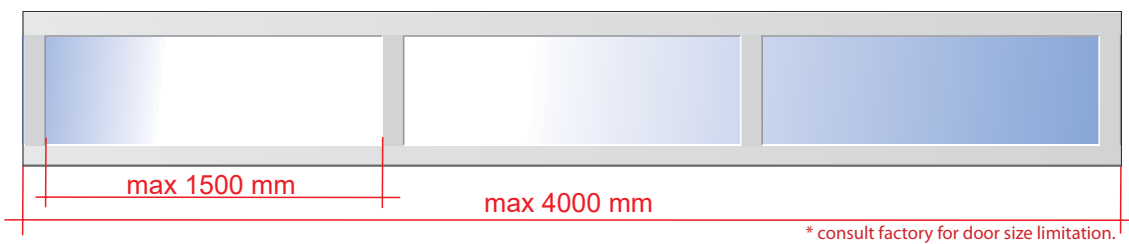

Polycarbonate glazing

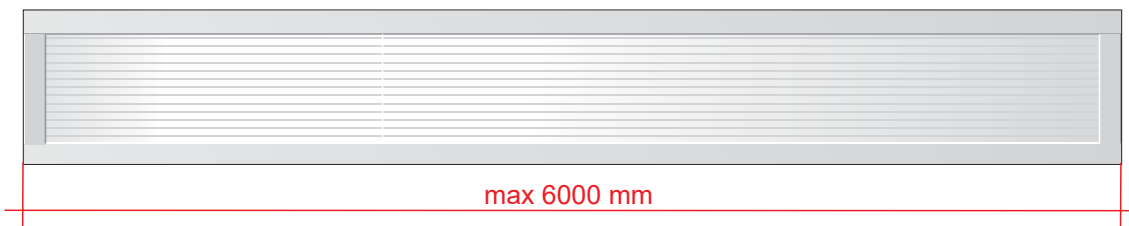

Continous glazing

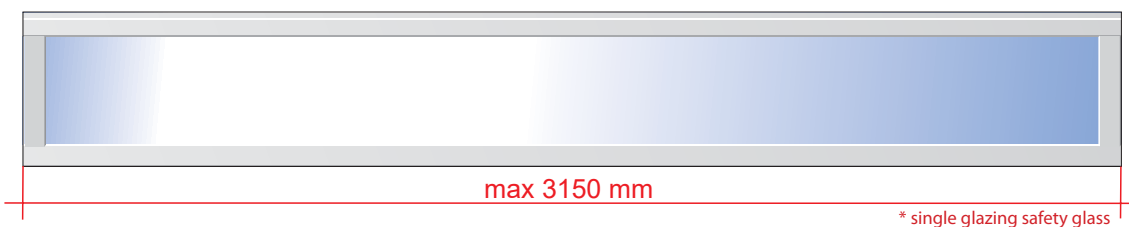
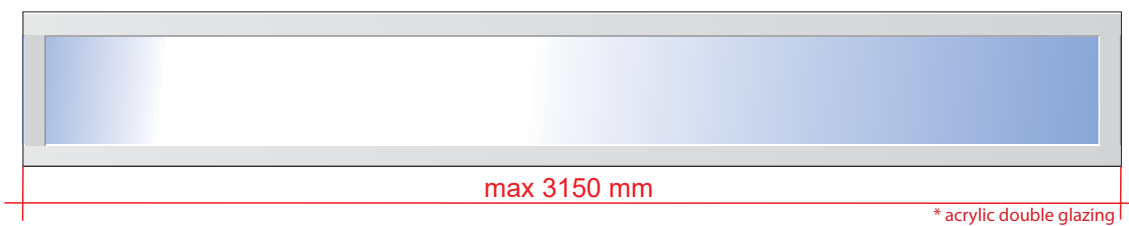

"Cross" decoration



RETRO

* custom Retro design upon request.

Retro Z

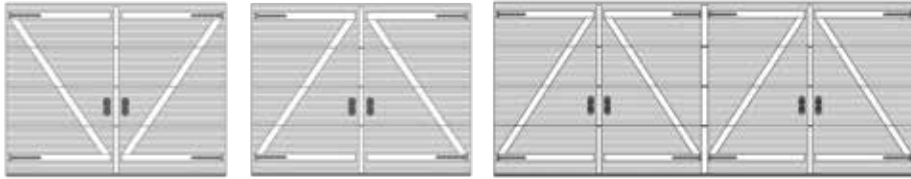

Retro X

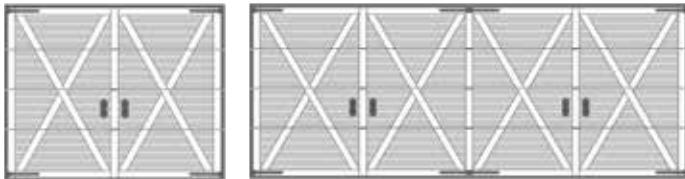

Retro H

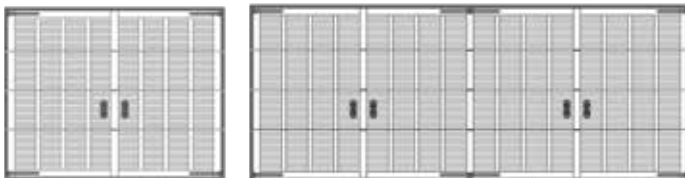

Retro S

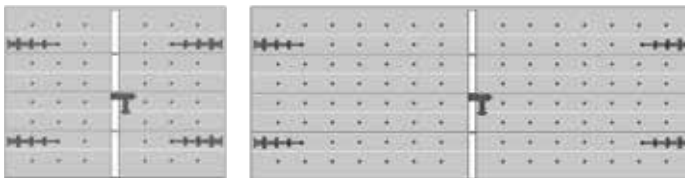

Retro Z - FV



Retro X - FV



Retro H - FV



DECOR APPLIQUÉS



STAINLESS METAL APPLIQUÉS OPTIONS

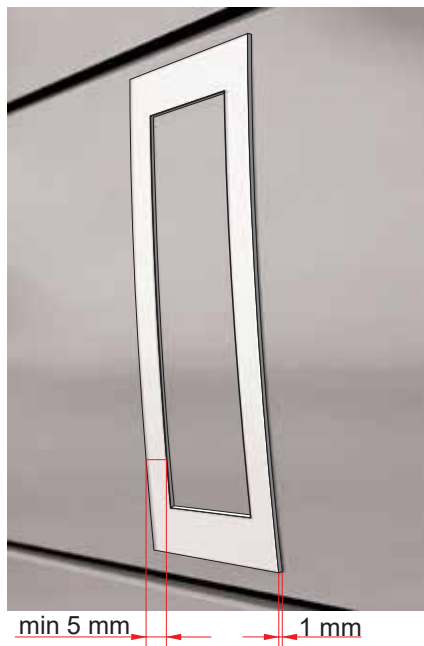

Brushed



RAL painted

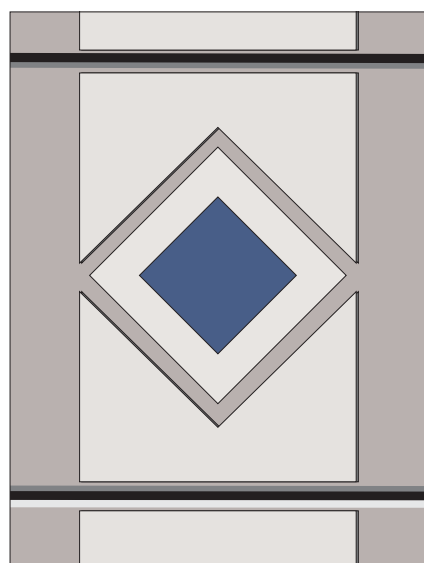

Appliques combined with windows

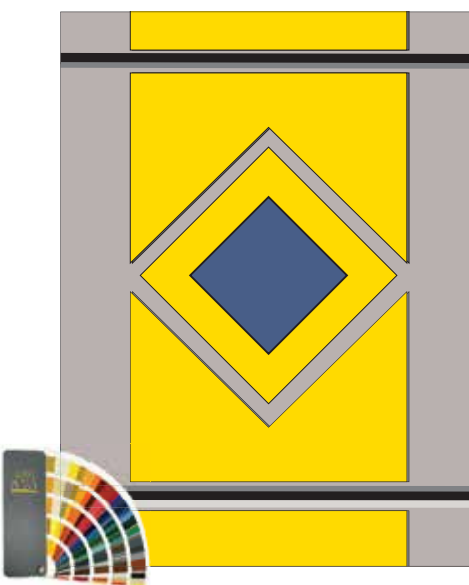

RAL painted appliques & windows

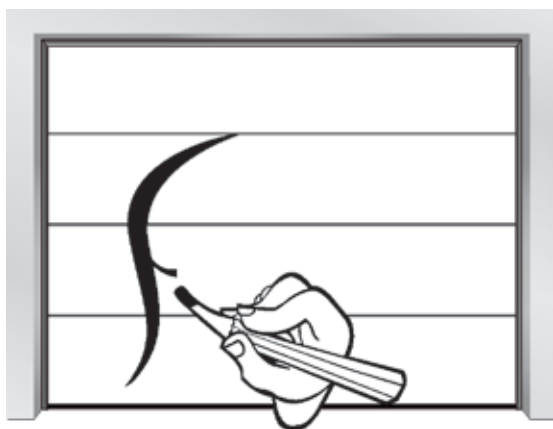

Individual design decorations available on request



For more information refer to Ryterna DESIGN catalogue

PVC WINDOWS



STAINLESS STEEL WINDOWS



PVC WINDOWS Scratch-proof double glazing

Standard acrylic double glazing windows (standard frame - white/black)

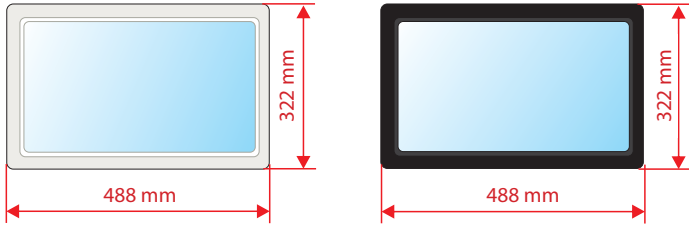

Painted RAL colours



"Cross" acrylic double glazing windows (standard frame - white)

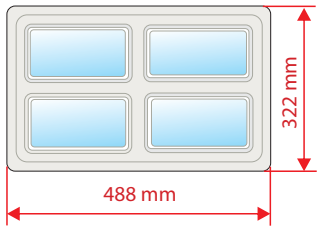

Painted RAL colours



"Sunrise" acrylic double glazing windows (standard frame - white)



Painted RAL colours

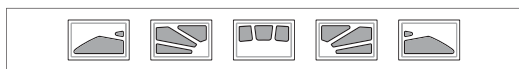
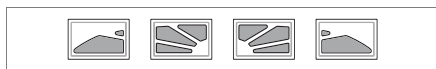
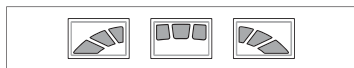
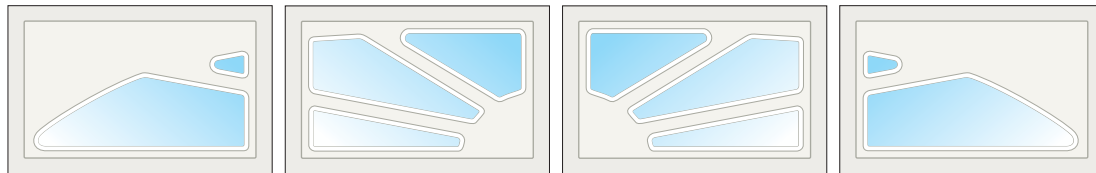

Acrylic double glazing windows location

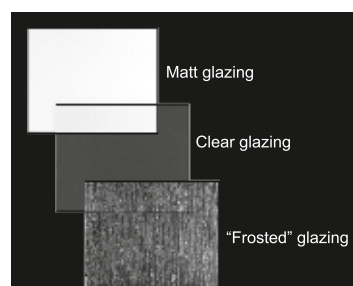
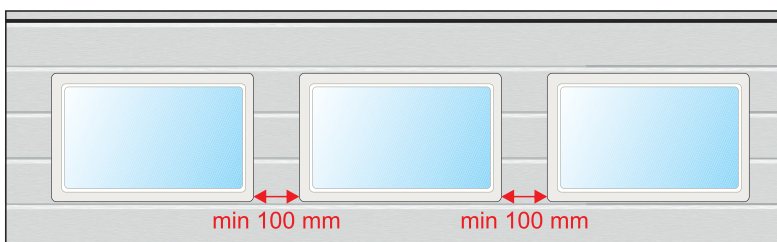

Stainless steel windows

Round stainless steel windows (single glazing safety glass)

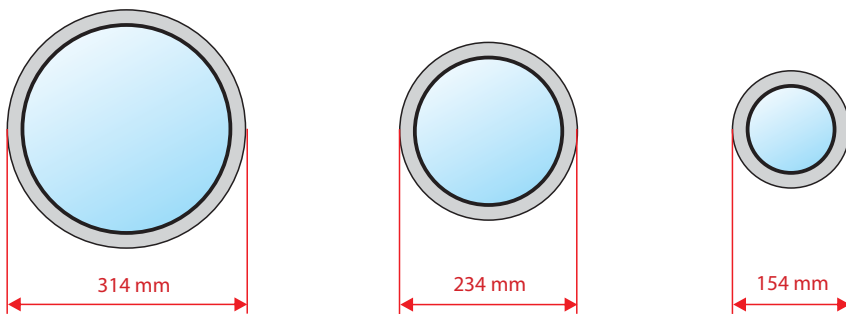

Painted RAL colours



Square stainless steel windows (double glazing safety glass)

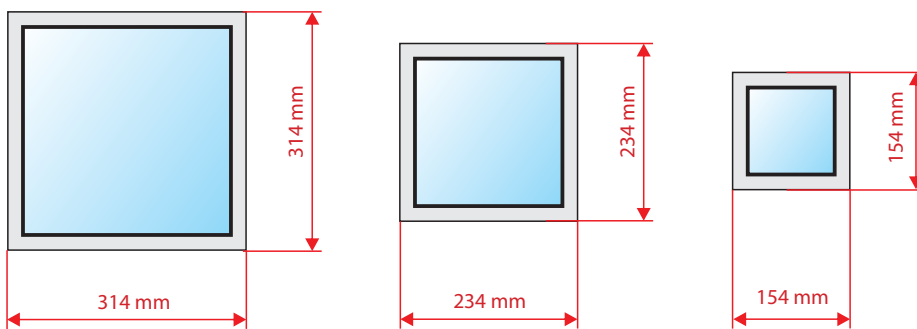

Painted RAL colours



Rectangular stainless steel windows (double glazing safety glass)

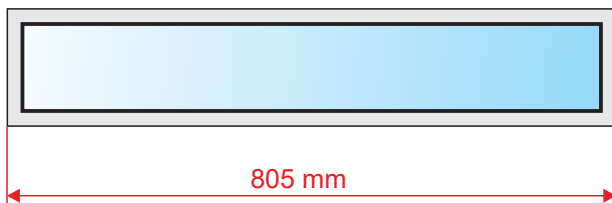

Painted RAL colours



Stainless steel windows location

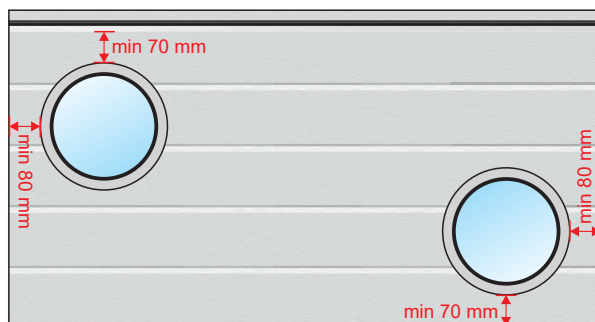

$W \leq 4500$

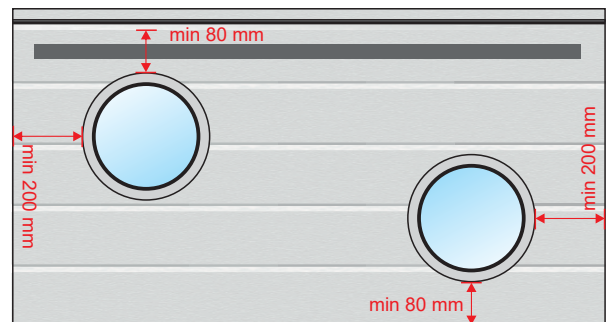

$4501 > W \geq 6000$

Type of glass



clear



matt



"frosted"



tinted

WICKET DOOR

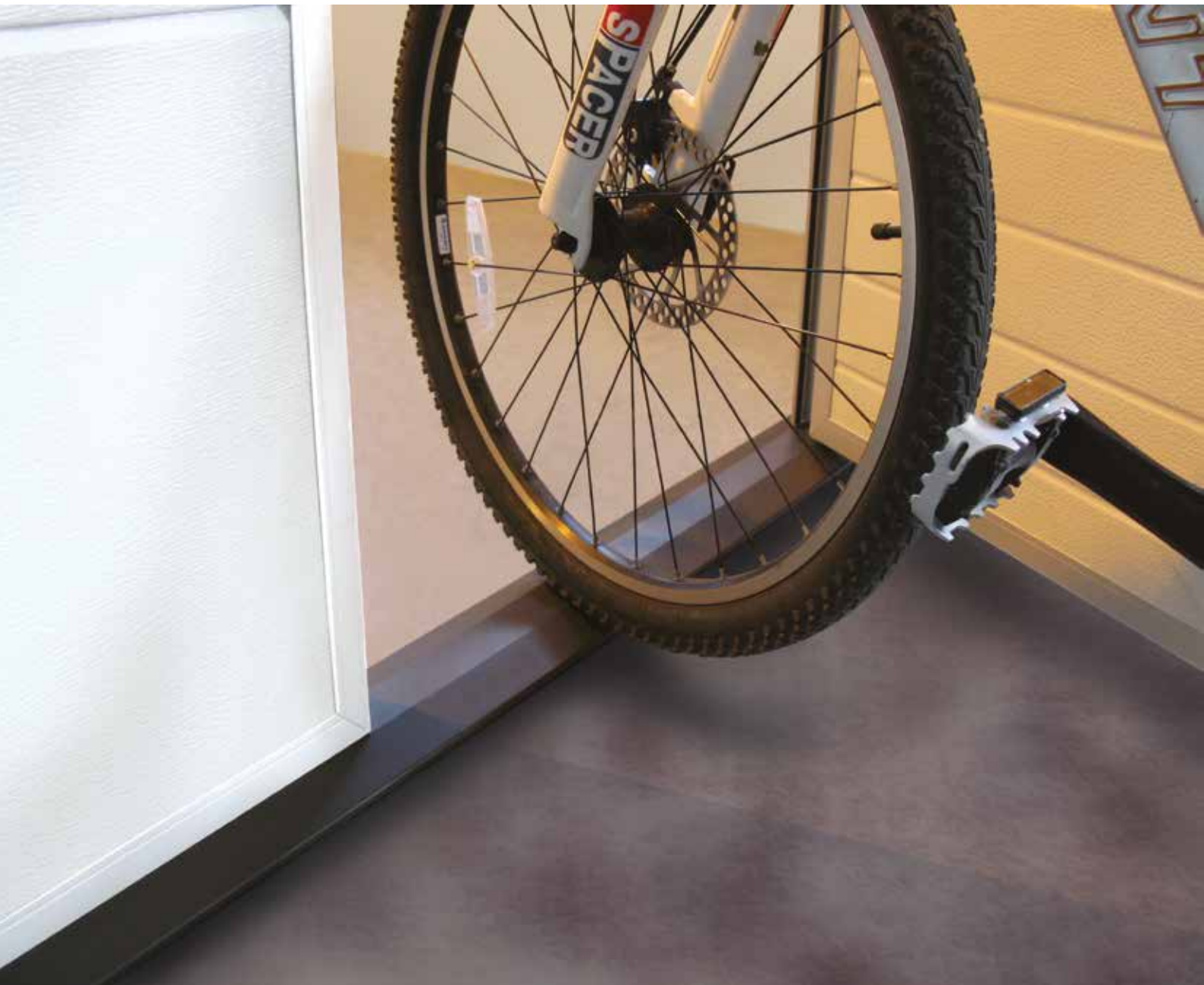

WICKET DOOR

Wicket door critical dimensions

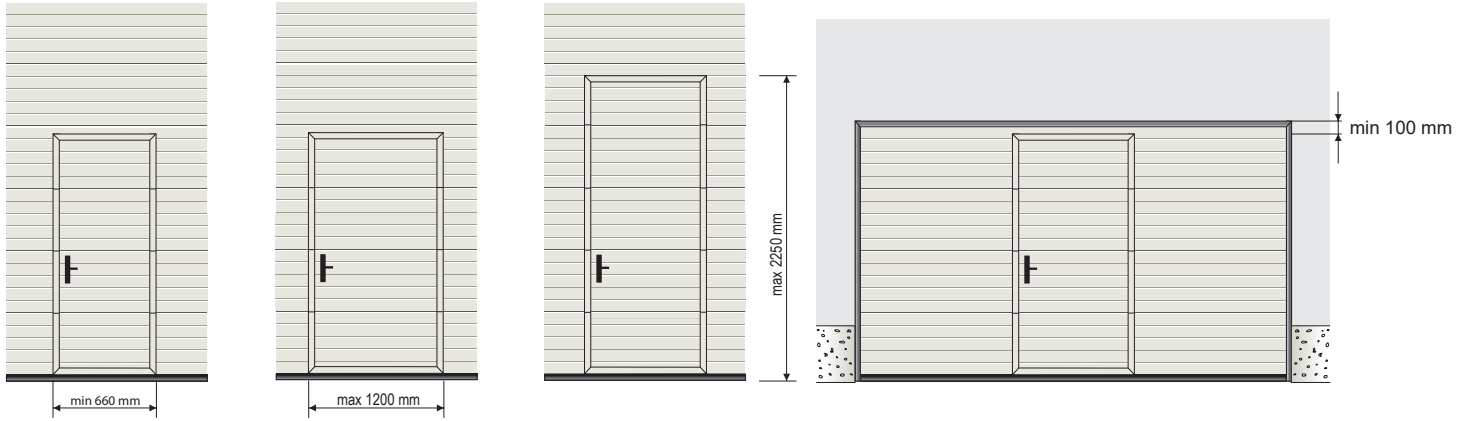

Wicket door with standard threshold

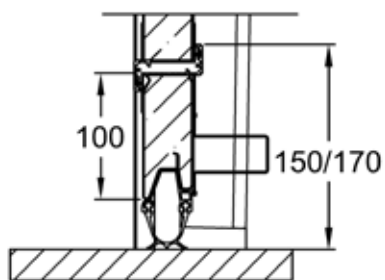
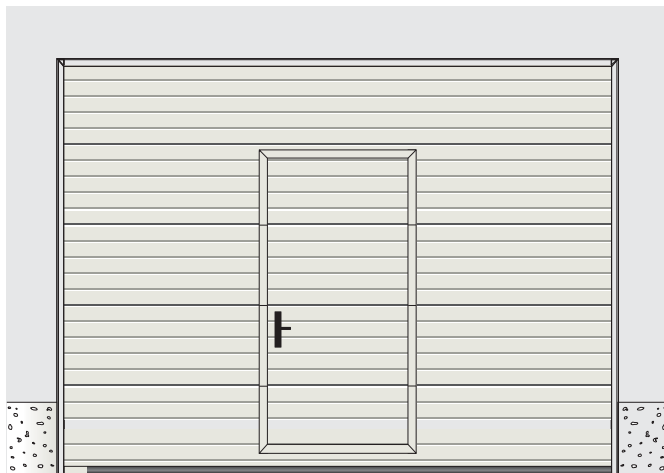

Wicket door with low threshold

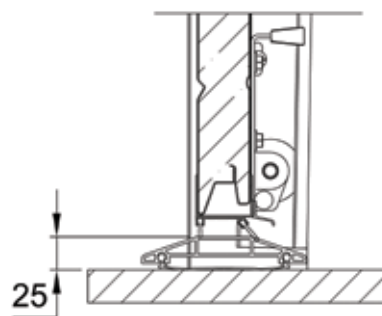
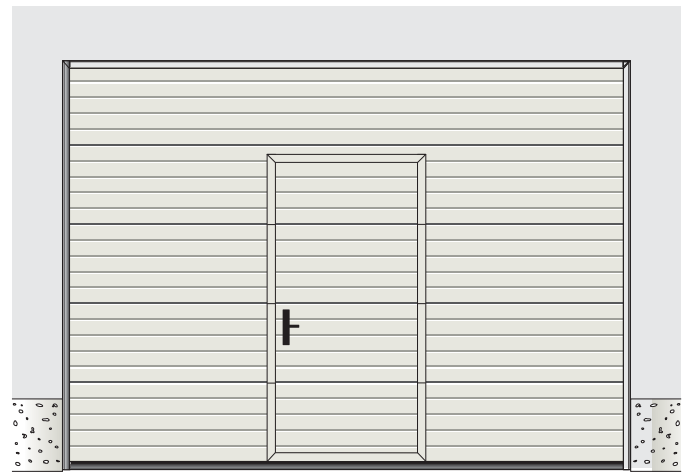

Handle options



white handle



aluminium handle



black handle

white handle - on white doors
 aluminium handle - on silver doors and by request
 black handle - on wood image and painted doors

WICKET DOOR

Standard threshold

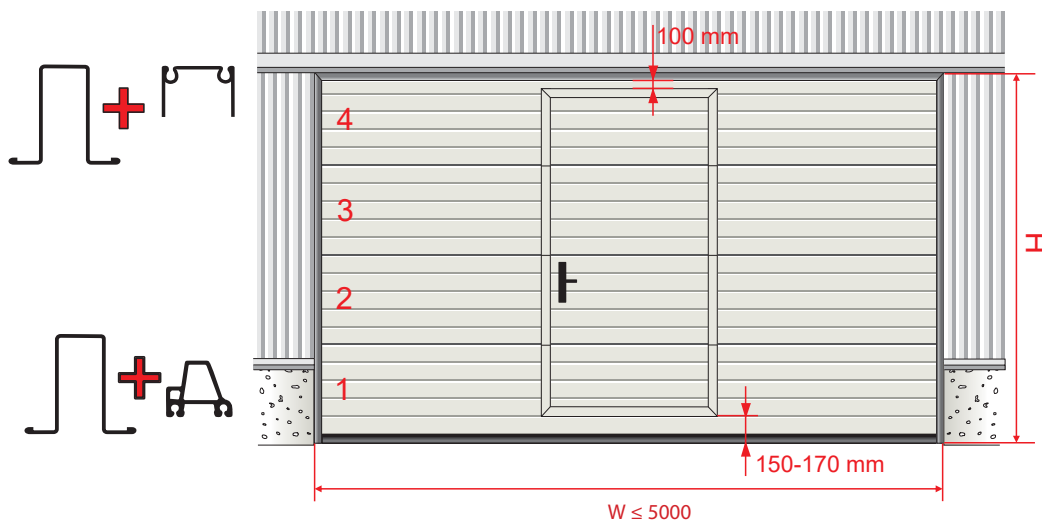

W > 5000 - on request

Low threshold

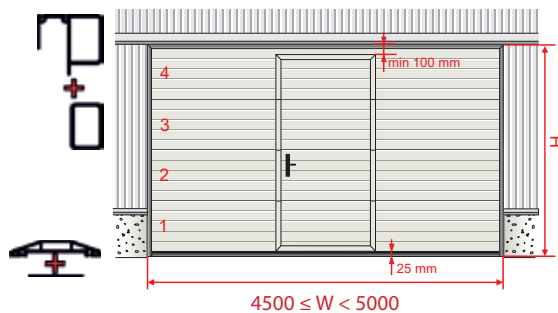
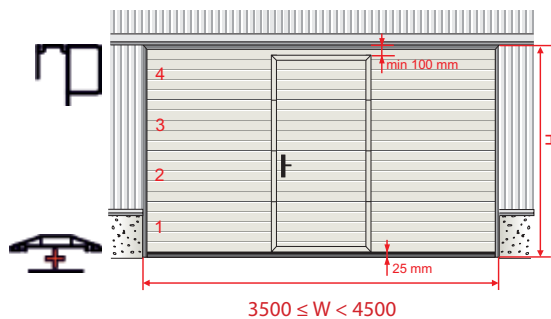
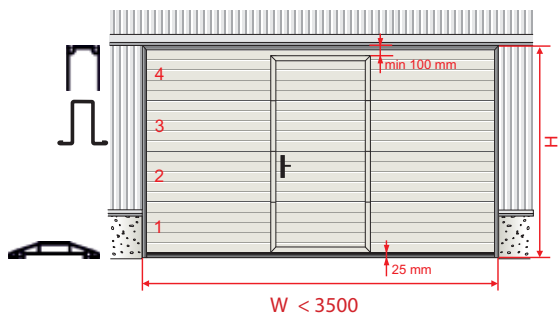
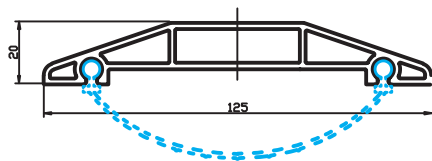

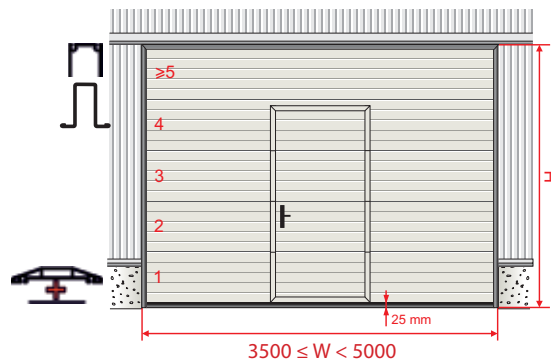
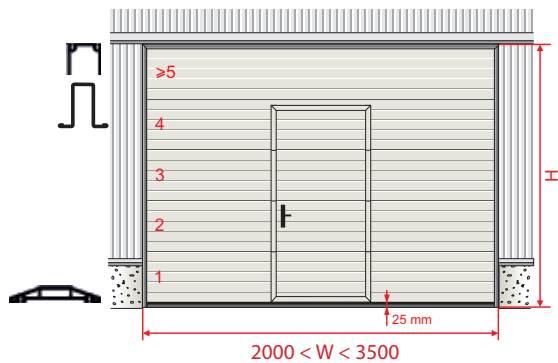

W > 5001 - on request.

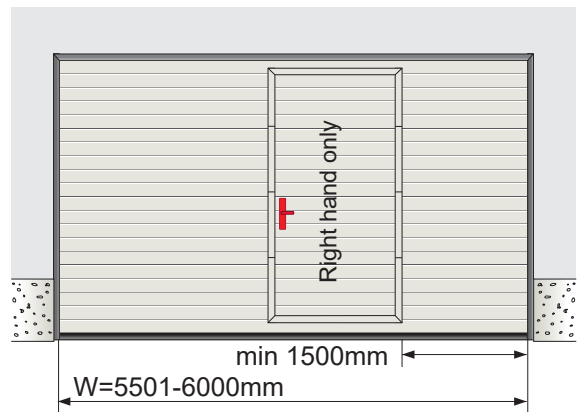
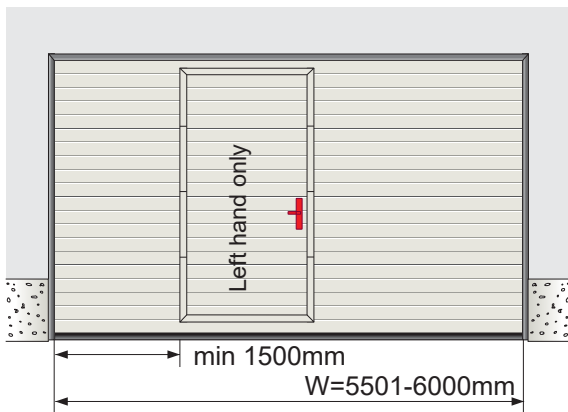
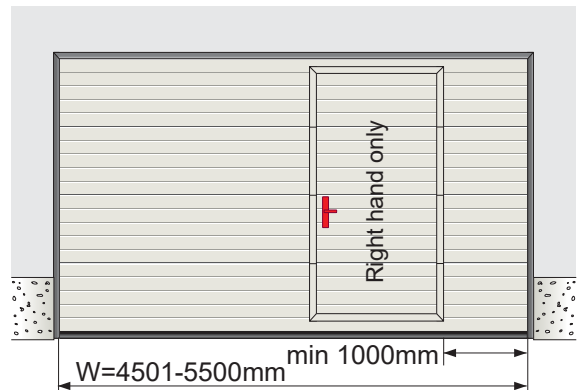
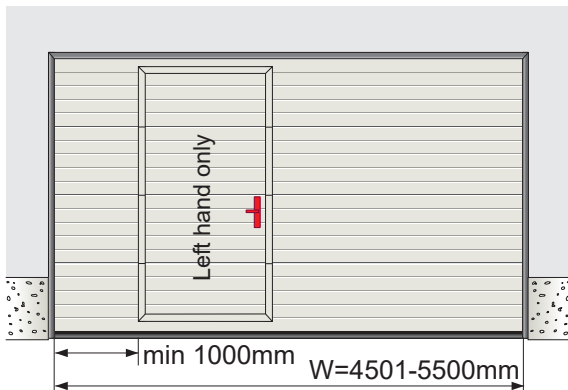
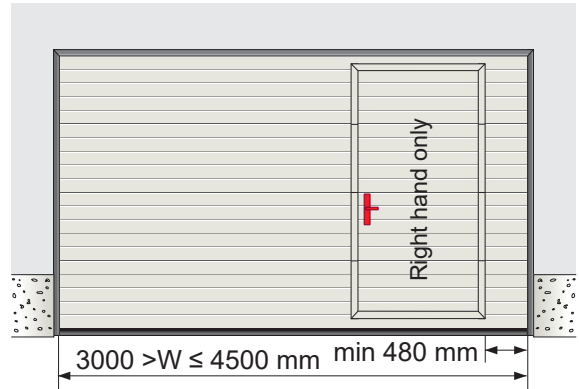
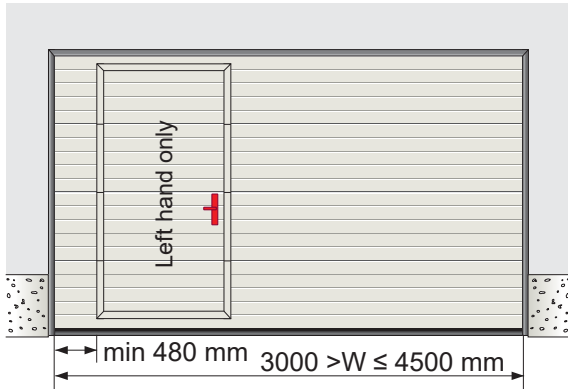

WICKET DOOR

External view



 Handle side (L/R) maybe chosen when the wicket door is in the middle

 Wicket door with higher threshold

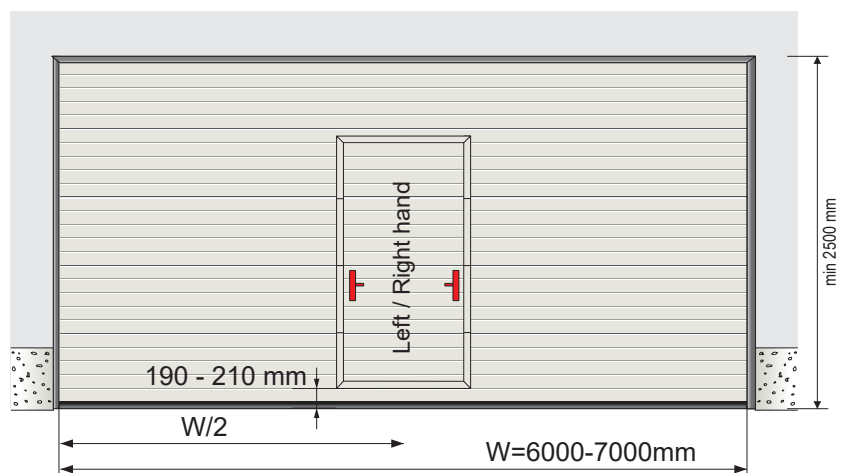
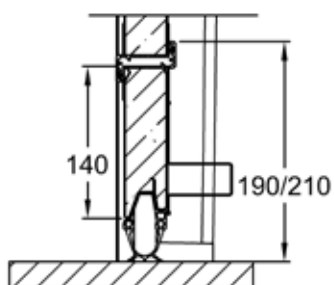

WICKET DOOR

CASSETTE panels

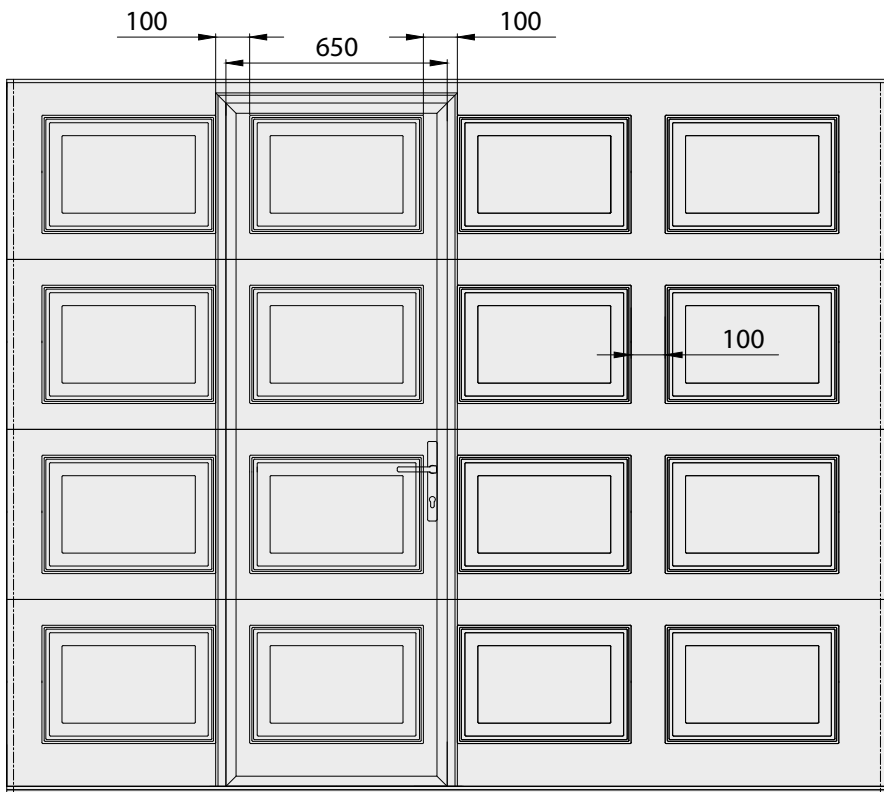
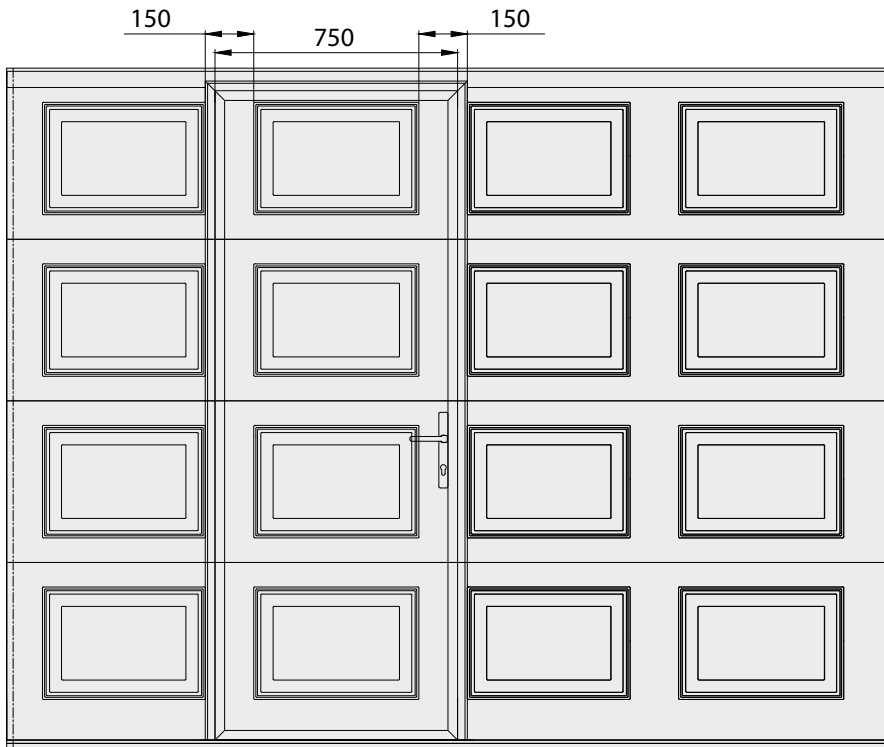

Foor doors with cassette panels and pass door consult manufacturer

SIDE-HINGED DOORS



SIDE DOOR (SH1)

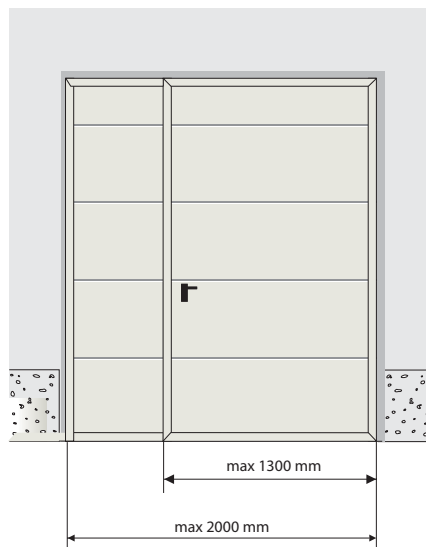
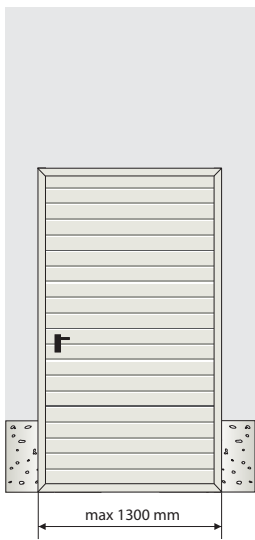
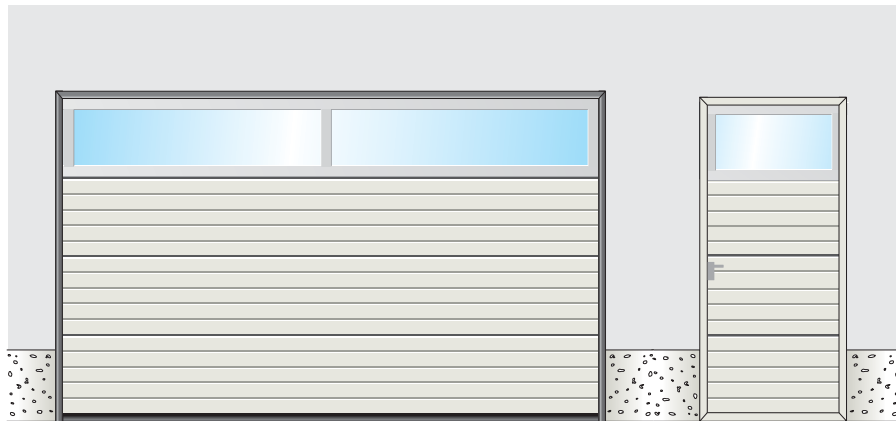
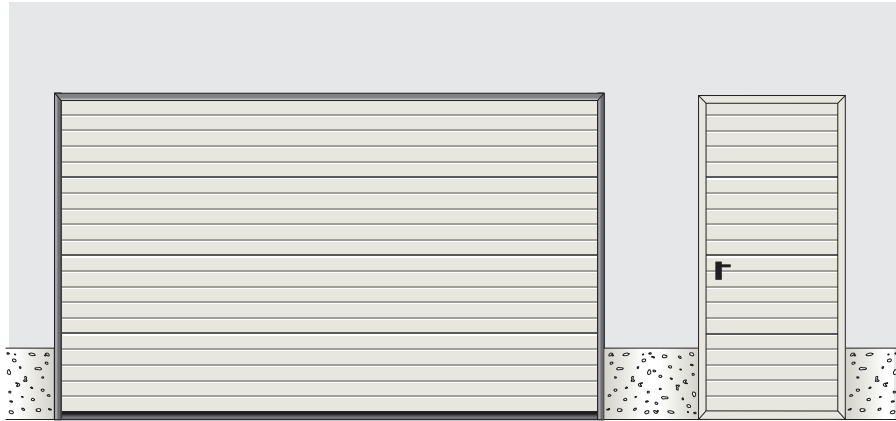

SIDE DOOR (SH1)

Side doors fitting and opening options

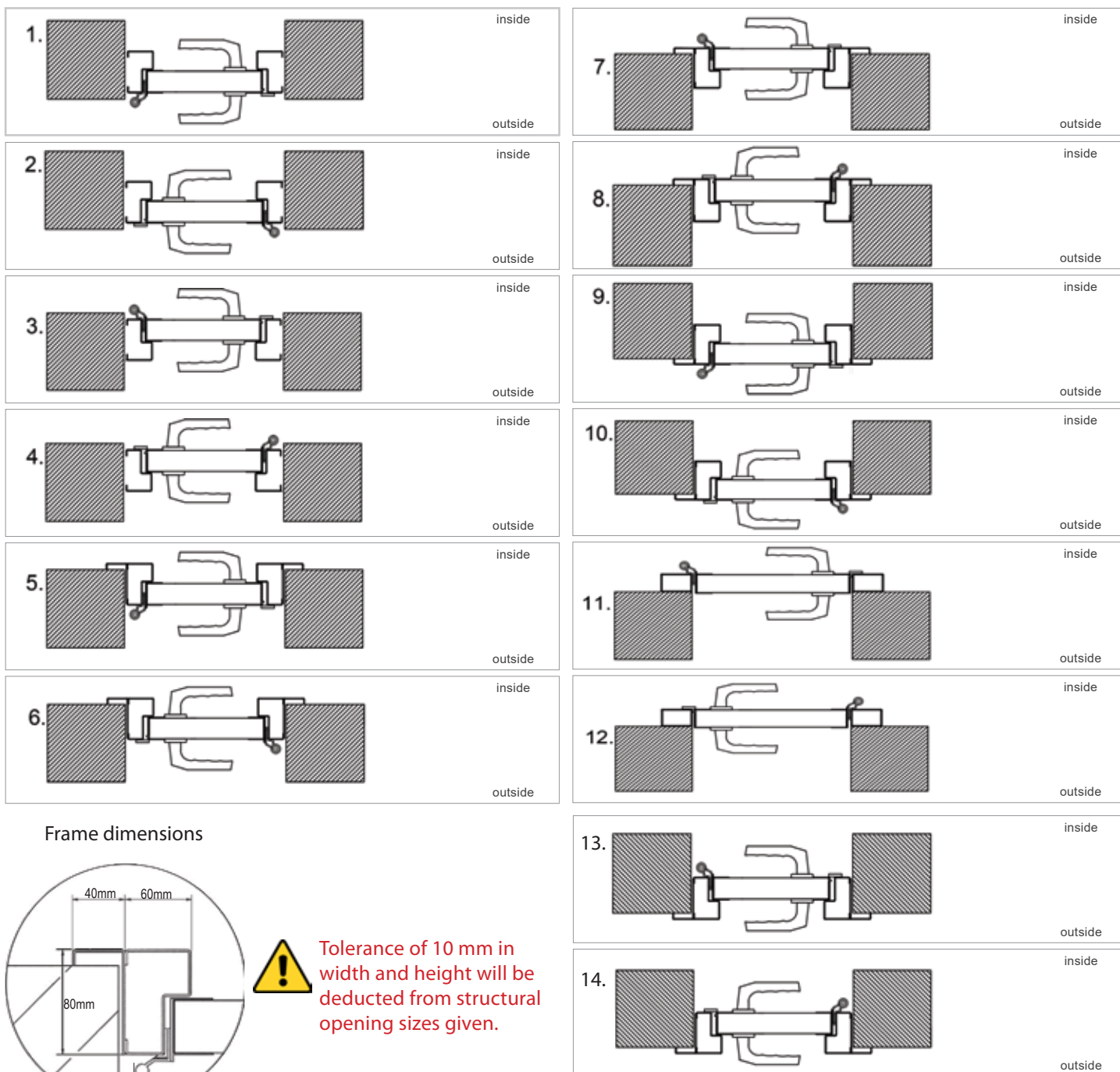

Frame dimensions

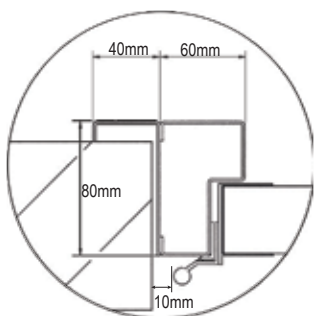

Tolerance of 10 mm in width and height will be deducted from structural opening sizes given.

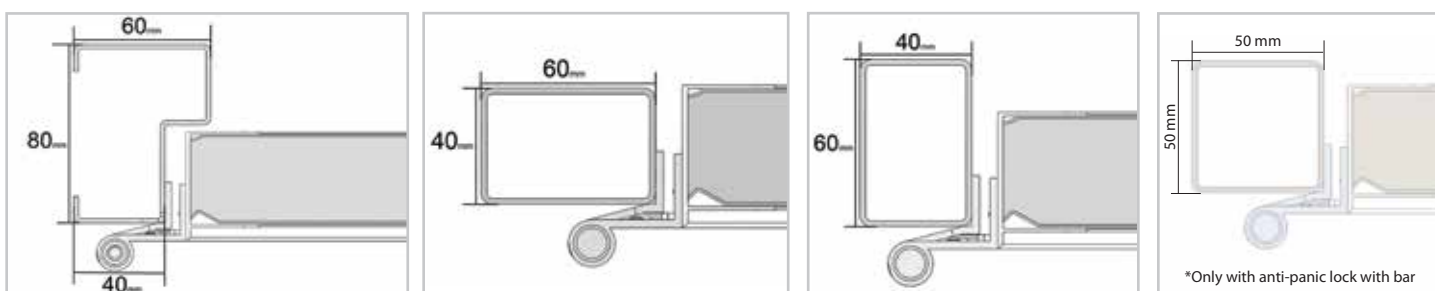

SIDE DOOR (SH1)

Side doors threshold types

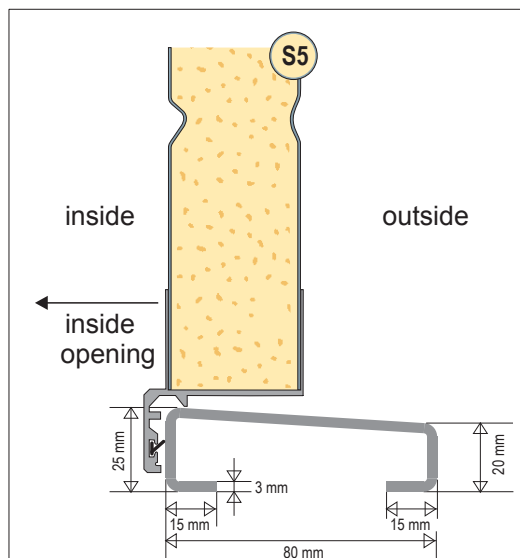
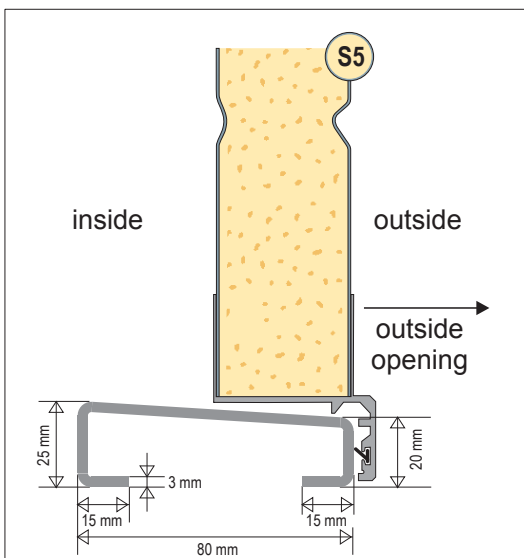
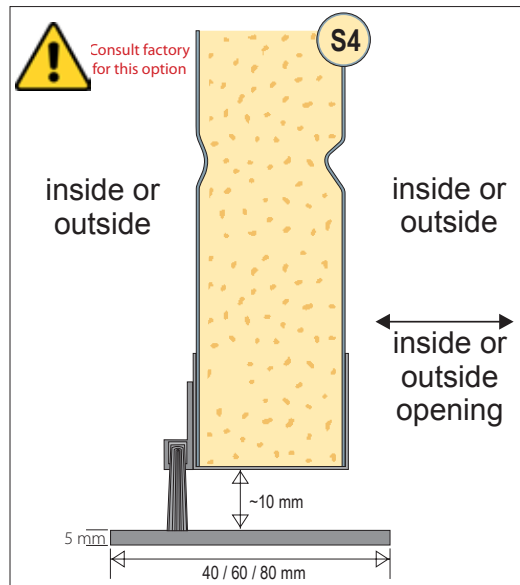
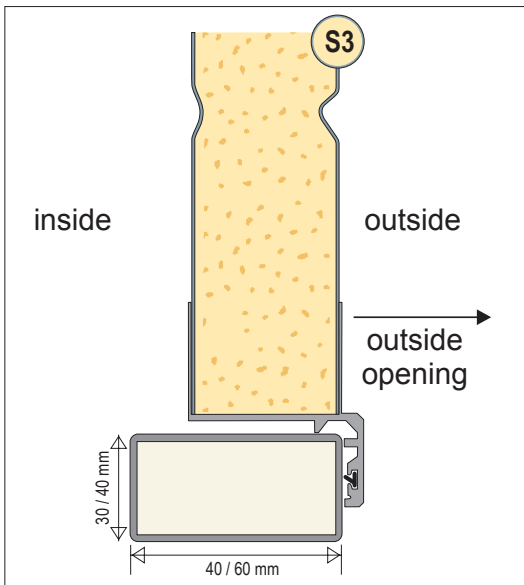
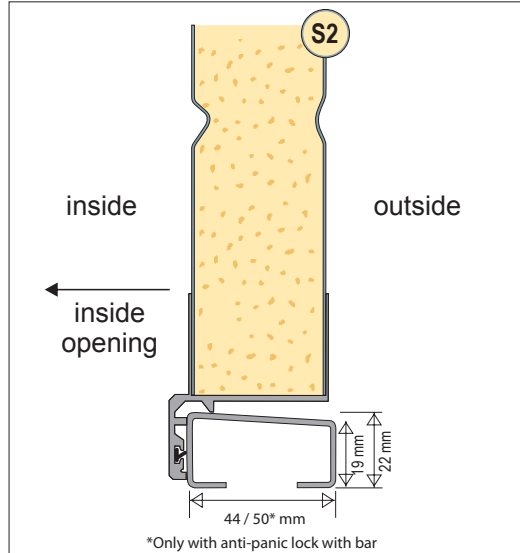
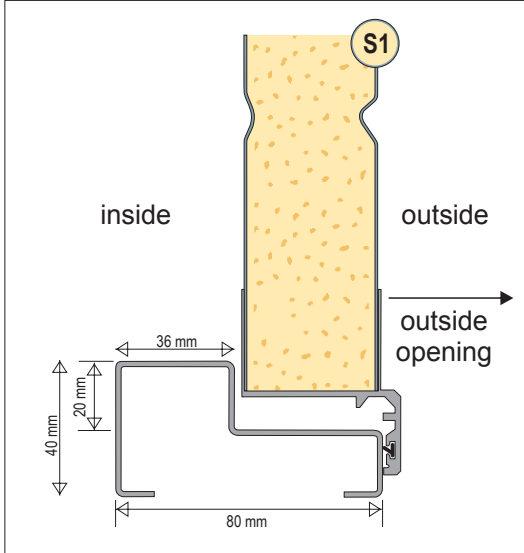

DOUBLE HINGED DOOR (SH2)

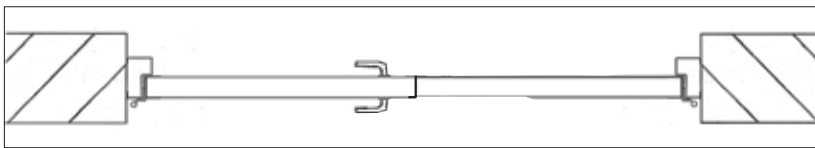
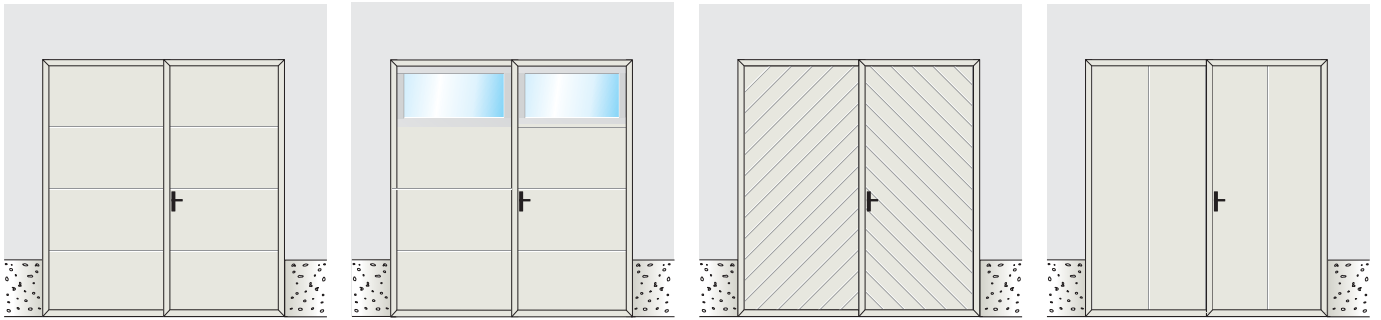

Two leaf doors are recommended when the opening is wider than 1300 mm.

Double side door critical dimensions

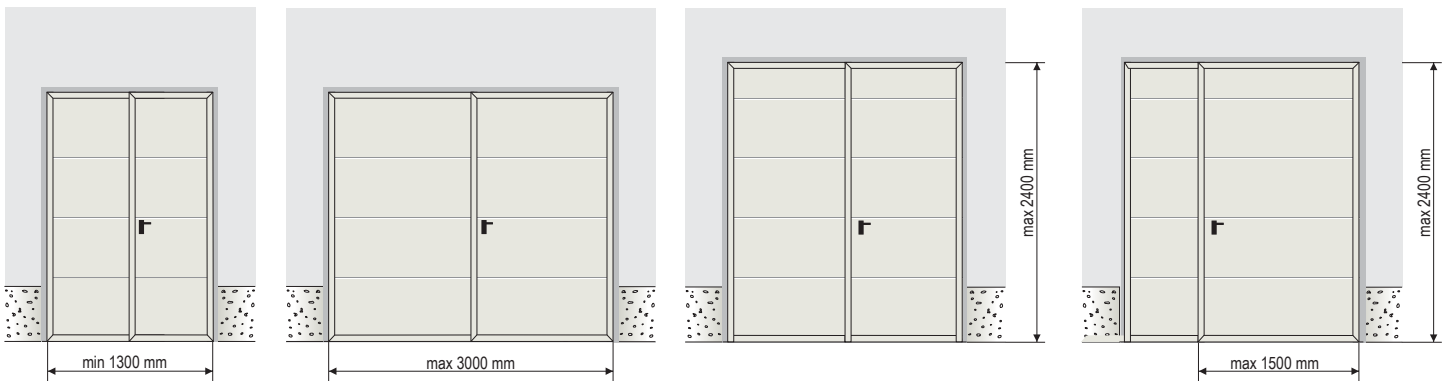

Frame dimensions

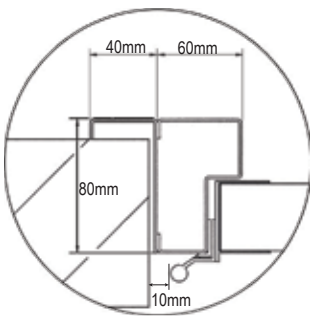

Tolerance of 10 mm in width and height will be deducted from structural opening sizes given.

Handle options



white handle



aluminium handle



black handle

white handle - on white doors
aluminium handle - on silver doors and by request
black handle - on wood image and painted doors

DOUBLE HINGED DOOR (SH2)

SH2 opening and handling options

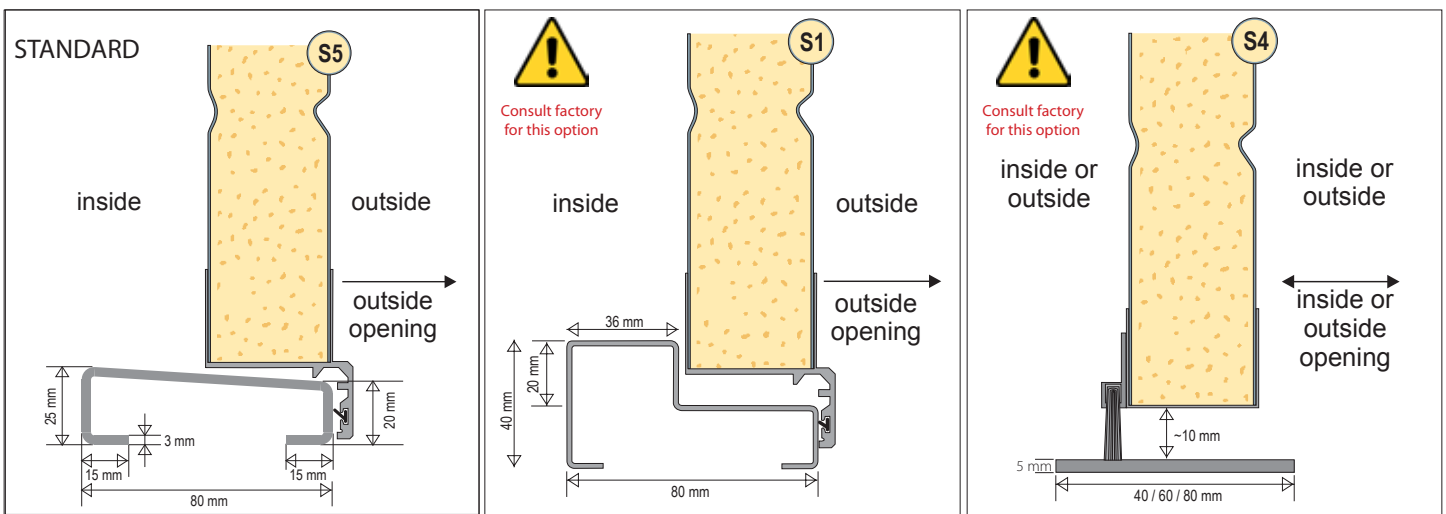
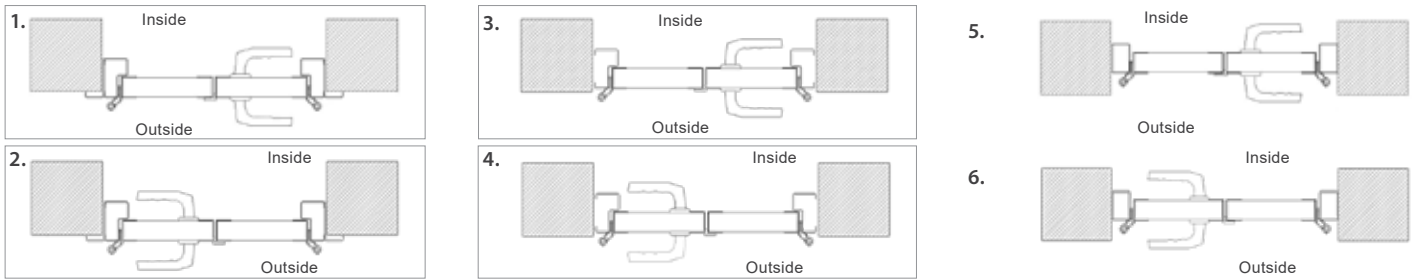

Locking options and door stays

